



M7 DeskPhone M5 DeskPhone M3 DeskPhone

User Manual

Introduction

Thank you for choosing an Alcatel-Lucent phone.

This document describes the services offered by the M3, M5 and M7 DeskPhones connected to a SIP server.



Alcatel-Lucent M7 DeskPhone (M7).



Alcatel-Lucent M5 DeskPhone (M5).



Alcatel-Lucent M3 DeskPhone (M3).

The phones described in this document are supported on different SIP servers, and some features described in this document depend on the SIP server to which the phone is connected.

If more information about system compatibility or about the level of features for a given SIP server is needed, please contact your system administrator.

The labels and icons displayed depend on the type and the skin of the set. The label is not displayed if the corresponding feature is not configured on your telephone system. Depending on the size of the display, some labels may be truncated. *All labels are displayed in color and are italicized.* This icon describes a succession of actions or labels you have to do or select: →.

This icon describes the consequence of an action: >>.

Some features depend on the type of the set.

	M7	M5	M3
IP Phone	●	●	●
Multiple SIP Accounts	●	●	●
Color screen	●	●	
Monochrome screen			●
Bluetooth® Smart Ready	●		
Compatible with Bluetooth ® headset	●		
USB headset	●	●	●
Wi-Fi dongle compatible*	●	●	●
Two-port Gigabit Ethernet switch with Power Over Ethernet support	●	●	●
Add-on module EM20	●	●	●
Add-on module EM200	●	●	●
Audio services (hands-free, handset and headset)	●	●	●
Adjust the brightness of the display	●	●	●
Local conference	●	●	●
Peer to peer SIP calls	●	●	●
Web Management	●	●	●
Desk sharing	●	●	●
Teleworking (OpenVPN)	●	●	●

*To know the supported dongle, please refer to the Alcatel-Lucent Enterprise website or contact your administrator.

The labels and icons presented in this document are not contractually binding and may be modified without prior warning.

1	Getting started	8
1.1	Unboxing	8
1.2	Install your desk phone	8
1.2.1	Install the foot	8
1.2.2	Connect the device	9
1.2.3	Install a comfort wired handset	9
1.3	Multiple SIP accounts	9
1.3.1	Program a line key for a SIP account	10
1.3.2	Define the default SIP account	10
2	Getting to know your telephone	11
2.1	M7 DeskPhone	11
2.1.1	Bluetooth® Smart Ready	12
2.2	M5 DeskPhone	13
2.3	M3 DeskPhone	14
2.4	Main screen	15
2.5	Call management screen	16
2.6	Navigation keys	16
2.7	Permanent features keys	17
2.8	Programmed key icons	18
2.9	Status icons/ Call icons	19
2.10	Alpha-numeric keyboard	20
2.11	Description of the connectors	21
3	Using your telephone	22
3.1	Information about the phone	22
3.1.1	More information about new events	22
3.2	Making call	22
3.2.1	Open the dialer	22
3.2.2	Calling by number	23
3.2.3	Making a peer to peer SIP call	24
3.2.4	Calling by name	24
3.2.5	Call from call log	25
3.2.6	Calling using your personal directory	25
3.2.7	Calling using speed dial key	26
3.3	Receiving a call	26
3.4	Switching between audio modes	26
3.5	Redialing	27
3.5.1	Call back the last number dialed	27
3.5.2	Call back one of the last numbers dialed	27
3.6	Contacts management	28
3.6.1	Contact card	28
3.6.2	Contacts management	29
3.6.3	Call your contact	30
3.6.4	Create a new contact in your local directory	30
3.6.5	Create a new group	31
3.6.6	Modify a contact	31
3.6.7	Delete a contact in a directory	31
3.6.8	Delete all contacts in a directory	31
3.6.9	Delete a group in the local directory	32
3.6.10	Delete all group in the local directory	32
3.6.11	Import contacts from your mobile phone via Bluetooth® (M7)	32

3.7	Manage the call log (History)	33
3.7.1	Call the contact	34
3.7.2	Display missed calls only	34
3.7.3	Acknowledge all new missed call logs	34
3.7.4	Delete a contact in the call log	34
3.7.5	Clear the call log	35
3.8	Speed dial management	35
3.8.1	Create a speed dial key	35
3.8.2	Make call using speed dial	35
3.9	Sending DTMF signals	35
3.10	Mute, so that your contact cannot hear you	36
3.11	Interphony (auto answer)	36
3.12	Make an intercom call	37
3.13	Configure the intercom incoming calls	37
3.14	Change PIN code	37
3.15	lock / unlock your telephone	38
3.15.1	Lock your phone	38
3.15.2	Unlock your phone	38
3.15.3	Activate or deactivate the automatic keypad lock	38
3.16	During conversation	39
3.17	Making a second call during a conversation	39
3.18	Answering a second call during a conversation	39
3.19	To cancel your second call and recover the first	40
3.20	Placing a call on hold (hold)	40
3.21	Switching between calls (Broker call)	41
3.22	Transferring a call	41
3.22.1	To transfer a call to another contact on hold	41
3.22.2	To transfer your call to another number	41
3.22.3	Blind transfer	42
3.23	Three-way conference	42
3.23.1	End the conference with all participants	42
3.23.2	After the conference, to leave your two contacts talking together	42
3.24	Talk simultaneously to more than 2 contacts (five-way conference with internal contacts) (M7, M5)	43
3.24.1	End the conference with all participants	43
3.25	Hide your phone number	43
3.26	Reject anonymous calls	44
3.27	Do not disturb	44
3.28	Forwarding to a number	45
3.29	Cancelling all forwards	45
3.30	Listen to your voicemail	46
3.31	Defining a 'hotline' number	46
4	Do more with your desk phone	47
4.1	Use your desk phone as a USB audiohub for your computer	47
4.1.1	Installation	47
4.1.2	Using your phone as an audio hub	50
4.2	Configure your phone for remote working	51
4.3	Connect your phone to the Wi-Fi	52
4.3.1	Configure the wireless network	52
4.3.2	Manage wireless network	53
4.4	Desk sharing	53

4.4.1	Login to desk sharing	54
4.4.2	Logout of desk sharing	54
4.5	Third-Party Call Control (3PCC) with Rainbow application	54
5	Programming your telephone	55
<hr/>		
5.1	Adjusting the audio functions	55
5.1.1	Select the melody	55
5.1.2	Adjusting the ringer volume	55
5.1.3	Configure the ringtone	55
5.1.4	Configuring discreet mode (beep)	56
5.1.5	Seat mode	56
5.2	Selecting language	56
5.3	Adjusting the brightness of the desk phone	56
5.4	Enable screensaver and define the delay	57
5.5	Define the voicemail number	57
5.6	Programmable keys	58
5.6.1	Create a programmable key	58
5.6.2	Delete a key	58
5.6.3	Type of programmed key	58
5.7	Call pick-up	60
5.8	Install a USB accessory (Headset, Handsfree, Loudspeaker)	60
5.9	Headset mode	60
5.10	Define time and date format	61
5.11	Manage Bluetooth® device (M7)	61
5.11.1	Installing a Bluetooth® device	61
5.11.2	List connected devices	62
5.11.3	Removing a Bluetooth® accessory (headset, handset, etc.)	62
5.11.4	Removing all Bluetooth® accessories	62
5.11.5	Edit the name of your desk phone	63
6	Contacting your administrator (technical support)	64
<hr/>		
6.1	Technical code / Date code	64
6.2	Software version / Display network settings (IP address)	64
6.3	Access to administrator configuration	65
6.3.1	Administrator settings menu	65
6.3.2	Web Management (WM)	65
7	Accessories	67
<hr/>		
7.1	List of accessories	67
7.1.1	USB headset	67
7.1.2	Add-on module	67
7.1.3	Conference module	67
7.1.4	Adapter	67
7.1.5	USB Dongle	67
7.1.6	Other accessories (headsets)	67
7.2	Add-on module	68
7.2.1	install the add-on to the desk phone	69
7.2.2	Install more than one add-on module	69
7.2.3	Changing or updating the paper label	70
7.3	Konftel EGO	71
7.3.1	Box content	71
7.3.2	Description	71
7.3.3	LED description	72

7.3.4	Icons displayed on the screen	72
7.3.5	Battery charge	72
7.3.6	Turning off and on	72
7.3.7	Connect the device to the desk phone using the USB cable	72
7.3.8	Connect the device to the desk phone using Bluetooth® (compatible Bluetooth® desk phone)	73
7.3.9	Using the Konftel EGO	73
7.4	Wall mounting kit	74
7.5	Developer and Solution Partner Program (DSPP)	74
8	Technical specifications	75
9	Ordering information	77
10	Guarantee and clauses	78

10.1	Safety Instructions	78
10.2	Regulatory Statements	79
	Quick guide	80

1 Getting started

1.1 Unboxing

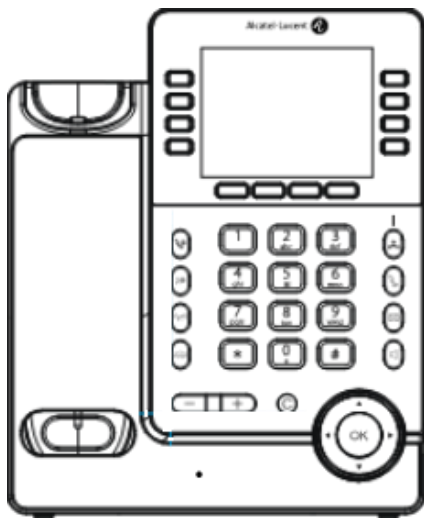

Deskphone



Handset cord



Handset



Ethernet cable

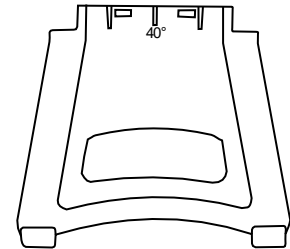

2-degree adjustable foot

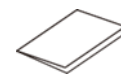

Safety and regulatory instructions

1.2 Install your desk phone

1.2.1 Install the foot

Clip the foot into its compartment behind the phone. Your desk phone provides a 2-degree foot. Depending on the way you insert the foot into the phone, your desk phone will have a different angle: 55° or 40°. The angle noted on the top of the foot (face up) corresponds to the angle that the phone will have after having inserted the foot.

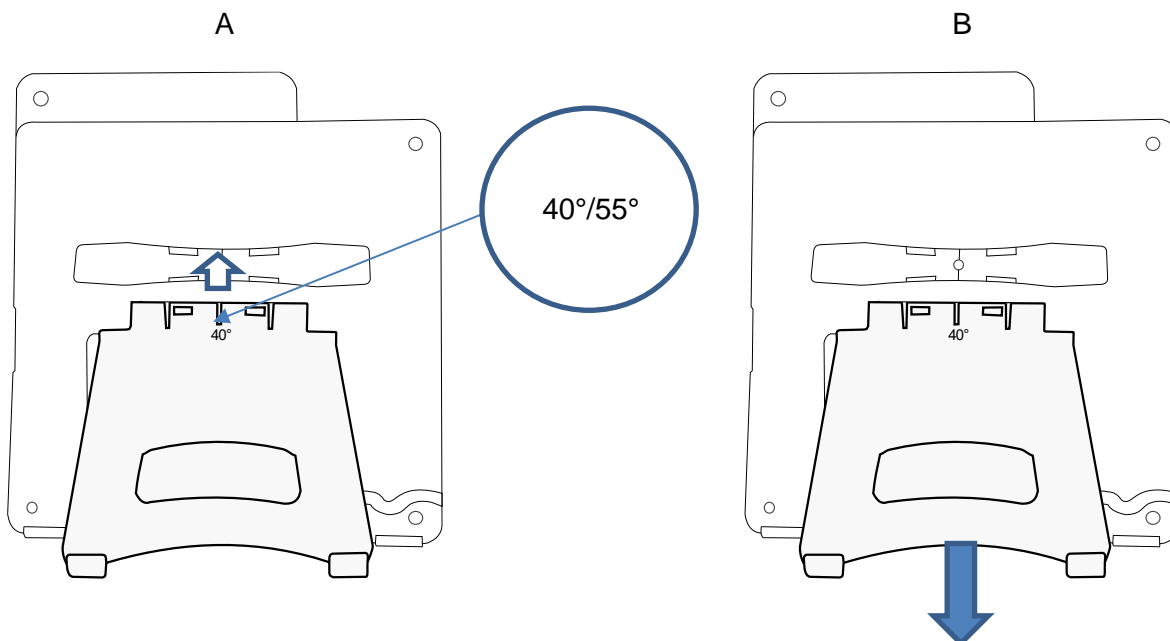

To unclip the foot, pull it straight back until it separates from the phone.

1.2.2 Connect the device

Please read safety instructions first.

Connect the handset (4) if it is not connected (your phone is usually provided with the handset connected).

If your desk phone is correctly configured, you can connect it to the network (2). If your desk phone is not powered by PoE (Power over Ethernet), you have to plug the power adapter to the USB-C connector (1) and connect it to the AC power supply. The power adapter is sold separately. For more information, contact your installer or administrator.

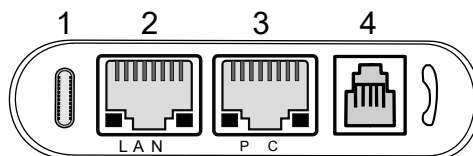

For more details, please consult the section: Description of the connectors.

1.2.3 Install a comfort wired handset

Your phone is provided with a connected handset.

If you have to replace it:

- Plug-in the wired handset to the appropriate connector (refer to phone description).
- Make sure you position the cable correctly in the compartment intended for that purpose.







1.3 Multiple SIP accounts

Your phone supports multiple SIP accounts. Your administrator can declare up to 4 SIP accounts. A default account is used for calls unless you select the relevant account prior the call. When you have programmed some function keys, you can associate a SIP account to the key.



It is recommended to program a key for each SIP account in the main page, as a line key. Then the status of the account is displayed on the homepage. The key of the SIP account receiving an incoming call is blinking.





	If the homepage displays an SIP account (line key), select the SIP account to use in order to make the call.
	The default SIP account is marked by a green point.
	Forward is activated for this account.
	Do not Disturb is activated for this account.

The call log lists all incoming and outgoing calls for all SIP accounts. The concerned SIP account is displayed by opening the details of the call log entry.

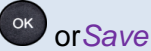
1.3.1 Program a line key for a SIP account

	Long press on a programmable key.
	Define the type of programmable key: <i>Account</i> Select the relevant account. Add a label.
	Save the programmable key.

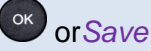
1.3.2 Define the default SIP account

	The phone is in idle state.
<i>Menu</i>	Press the Menu soft key to access the Main Menu.
<i>Features</i>	Use up-down and 'ok' navigation keys to select: <i>Features</i> .
<i>Default Account</i>	Use up-down and 'ok' navigation keys to select: <i>Default Account</i> .
	Select the default SIP account.
	Validate your choice.
	To end the settings.

2 Getting to know your telephone

2.1 M7 DeskPhone

This phone is part of the IP phone range. With its color display associated to 12 dedicated functions keys, and an intuitive navigation key, the M7 DeskPhone delivers excellent user experience and optimum conversation convenience with outstanding audio quality in either hands-free mode or when using the comfort handset. It is 'Bluetooth® Smart Ready'. Your phone is very easy to use thanks to its natural perception user interface. Your experience is further enhanced with Bluetooth® accessories. It is compatible with remote working. By this way, it is perfect for use at your office in your enterprise or at home (remote working).

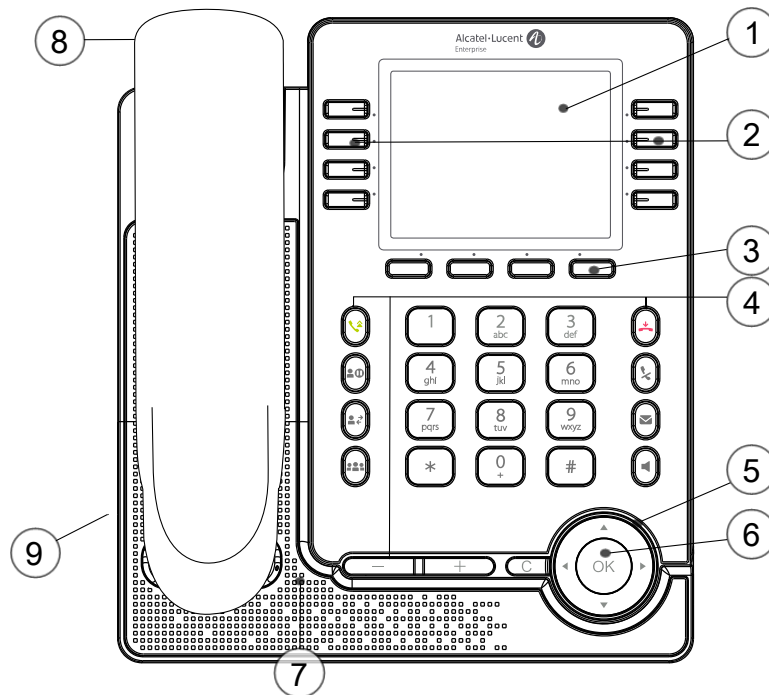

1	3.5 inch color display.	6	Navigation.
2	28 programmed keys: SIP account, speed dial, functions. Use navigation keys to navigate through pages of programmable keys.	7	<ul style="list-style-type: none"> • Super wideband loudspeaker for optimized sound. • Microphone.
3	Softkeys: menus and actions available depending on the selected page. Softkeys are configurable by the administrator. <ul style="list-style-type: none"> • Idle state: menu to access features and configure the phone or manage calls. Use the navigation keys to navigate through the menus. • In conversation: available actions. 	8	Wired handset (wide band audio quality).
4	Permanent feature keys: quick access to the phone's main features.	9	2-degree adjustable foot (55°, 40°).
5	LED Flashing blue: incoming calls, new events displayed on the screen (voice messages, missed calls). Blue steady: ongoing call.		

2.1.1 Bluetooth® Smart Ready



Your phone is 'Bluetooth® Smart Ready'. It can receive and share Bluetooth® signals from various Bluetooth® devices (Bluetooth® and Bluetooth® Smart or Low-energy devices). It is ready for future services available on the fly in a subsequent software upgrade. This feature can be deactivated by the administrator.

2.2 M5 DeskPhone

This phone is part of the IP phone range. In addition to a color display associated to 12 dedicated function keys and an intuitive navigation key, the M5 DeskPhone delivers excellent user experience and optimum conversation convenience with an outstanding audio quality in either hands-free mode or when using the comfort handset. Your phone is very easy to use thanks to its natural perception user interface. It is compatible with remote working. By this way, it is perfect for use at your office in your enterprise or at home (remote working).

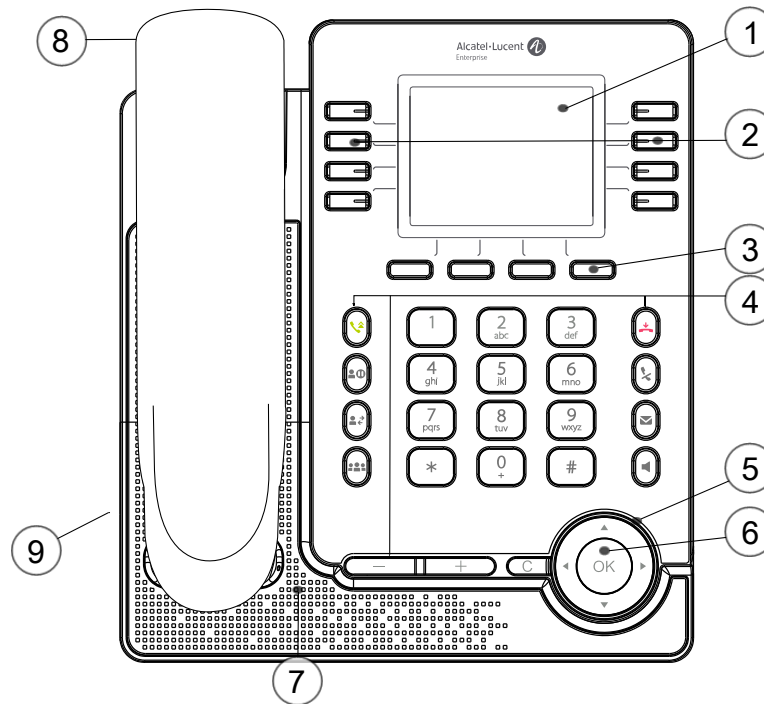

1	2.8 inch color display.	6	Navigation.
2	28 programmed keys: SIP account, speed dial, functions. Use navigation keys to navigate through pages of programmable keys.	7	<ul style="list-style-type: none"> • Super wideband loudspeaker for optimized sound. • Microphone.
3	Softkeys: menus and actions available depending on the selected page. Softkeys are configurable by the administrator. <ul style="list-style-type: none"> • Idle state: menu to access features and configure the phone or manage calls. Use the navigation keys to navigate through the menus. • In conversation: available actions 	8	Wired handset (wide band audio quality).
4	<ul style="list-style-type: none"> • Permanent feature keys: quick access to the phone's main features. 	9	2-degree adjustable foot (55°,40°).
5	LED Flashing blue: incoming calls, new events displayed on the screen (voice messages, missed calls). Blue steady: ongoing call.		

2.3 M3 DeskPhone

This phone is part of the IP phone range. In addition to a clear monochrome display associated to 10 dedicated function keys and an intuitive navigation key, the M3 DeskPhone provides high audio fidelity for telephone calls either in hands-free mode or when using the comfort handset. Your phone is very easy to use thanks to its natural perception user interface. It is compatible with remote working. By this way, it is perfect for use at your office in your enterprise or at home (remote working).

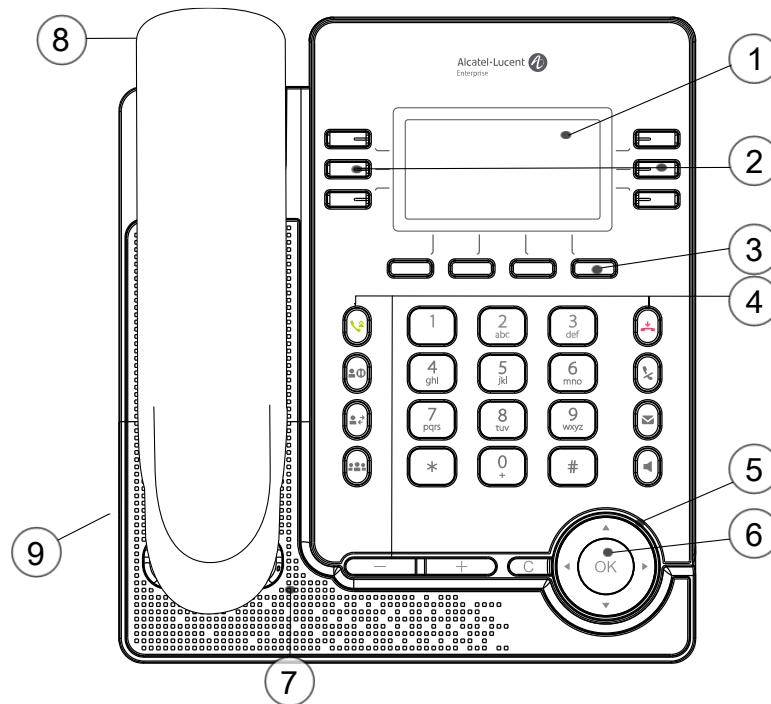

1	2.8 inch monochrome display.	6	Navigation.
2	20 programmed keys: SIP account, speed dial, functions. Use navigation keys to navigate through pages of programmable keys.	7	<ul style="list-style-type: none"> • Super wideband loudspeaker for optimized sound. • Microphone.
3	Softkeys: menus and actions available depending on the selected page. Softkeys are configurable by the administrator. <ul style="list-style-type: none"> • Idle state: menu to access features and configure the phone or manage calls. Use the navigation keys to navigate through the menus. • In conversation: available actions. 	8	Wired handset (wide band audio quality).
4	Permanent feature keys: quick access to the phone's main features.	9	2-degree adjustable foot (55°, 40°).
5	LED Flashing blue: incoming calls, new events displayed on the screen (voice messages, missed calls). Blue steady: ongoing call.		

2.4 Main screen

Your phone can support up to 4 SIP accounts.

The main screen, composed with 4 pages, displays all programmed keys which can be a line key for a registered SIP account, a speed dial or other functions.

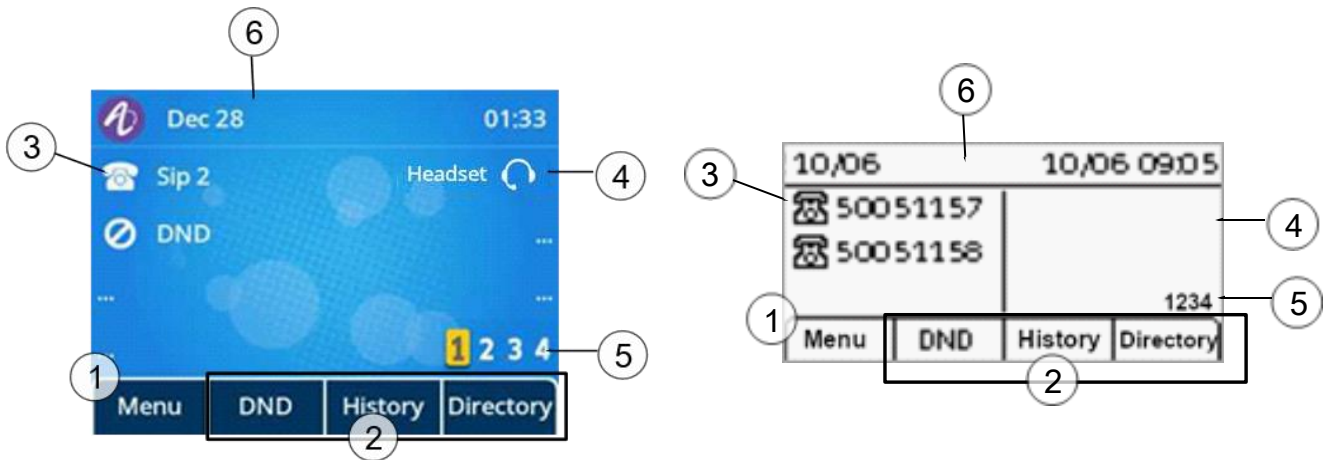

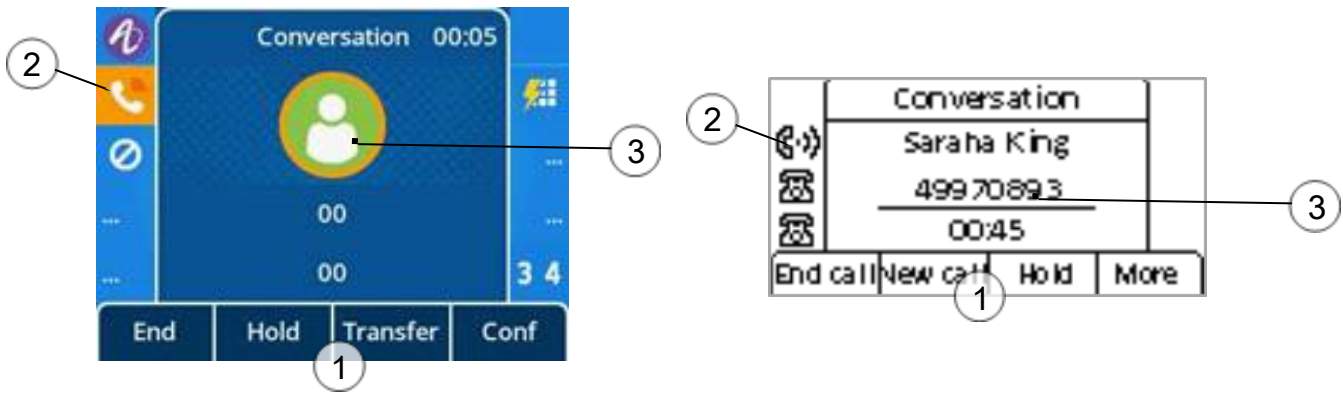

<p>1</p>	<p>Menu to access features and configure the phone or manage calls. Press the menu softkeys under the screen to access features. Use the up-down navigation keys to navigate through the menus and to select an entry or an option.</p>
<p>2</p>	<p>3 dynamic keys configurable by your administrator to access features of the phone.</p>
<p>3</p>	<p>Line keys associated with SIP account (optional). Press the line key associated with a SIP account to make a call with this account or to answer an incoming call to this account.</p>
<p>4</p>	<p>Programmed keys. Press the programmed key to use the programmed function or contact. Long press the programmed key to enter into the key configuration. The 'headset' programmed key allows you to switch to headset mode.</p>
<p>5</p>	<p>Access to 4 pages. Use the right-left navigation keys or the '1234' programmed key to navigate between pages. The number of the displayed page is highlighted.</p>
<p>6</p>	<p>Date, time and status bar.</p>

2.5 Call management screen













1	Softkeys: actions available depending on the call status. Press the softkey under the label to select the corresponding feature.
2	SIP account in conversation.
3	Incoming call and conversation presentation screen.

2.6 Navigation keys

	<p>OK key: Use this key to validate your choices and options while programming or configuring (short press).</p>
	<p>left-right navigator: Use to move from one page to another or to move the cursor in a text box.</p>
	<p>up-down navigator: Use to select an item on a list. When information extends over more than one page, use the down navigation key to display the next page. Use the up navigation key to display the previous page.</p>
	<p>Back/Exit key: Use this key to go back to the previous step.</p>
<i>Bkspc</i>	Use this key to delete the previous input letter or number in the text box.
<i>More</i>	Open other functions.

Use the up-down navigation keys to navigate through the menus and to select an entry or an option.

2.7 Permanent features keys

	<ul style="list-style-type: none"> • Take the call key. • Redialing the last number dialed (long press). • List of last numbers dialed (short press).
	<ul style="list-style-type: none"> • Placing a call on hold. • Recover the call on hold.
	<ul style="list-style-type: none"> • Transfer a call.
	<ul style="list-style-type: none"> • Starting a conference call with two contacts.
	<ul style="list-style-type: none"> • Reject incoming call. • Hang up. • Return to the main page.
	<ul style="list-style-type: none"> • Mute key During a call, press this key to stop your contact from hearing you. When activated, the key is lit red.
	<ul style="list-style-type: none"> • Access the voice mail The message key flashes red when you have received a new voicemail or a missed an incoming call. The key stays on if there are old messages in the voicemail box.
	<ul style="list-style-type: none"> • Press this key to open dialer in hands-free mode (idle state). • Pressing this key answers an incoming call in hands-free mode (idle state). When a call is in progress, pressing this key switches from hands-free mode to headset or handset mode. When activated, the key is lit blue. • Hang up in hands-free mode if the headset mode is not activated.
	<ul style="list-style-type: none"> • Decrease the volume of the ring tone (9 steps) in idle state or when you receive an incoming call. • Decrease the volume of the handset, loudspeaker or headset (7 steps) during a conversation.
	<ul style="list-style-type: none"> • Increase the volume of the ring tone (9 steps) in idle state or when you receive an incoming call. • Increase the volume of the handset, loudspeaker or headset (7 steps) during a conversation.

2.8 Programmed key icons

This table lists icons displayed on the screen when you program a key. To program a key, see chapter: Programmable keys. The following icons are listed when the phone is in an idle state and can be changed depending on the status of the phone or the contact's phone.

	<ul style="list-style-type: none"> • SIP account.
	<ul style="list-style-type: none"> • Speed dial.
	<ul style="list-style-type: none"> • BLF/BLF List (Busy Lamp Field).
	<ul style="list-style-type: none"> • Hold.
	<ul style="list-style-type: none"> • Transfer.
	<ul style="list-style-type: none"> • Conference.
	<ul style="list-style-type: none"> • Recall the last number.
	<ul style="list-style-type: none"> • Do not disturb.
	<ul style="list-style-type: none"> • Directory.
	<ul style="list-style-type: none"> • Forward.
	<ul style="list-style-type: none"> • Voicemail.
	<ul style="list-style-type: none"> • Hot Desking.
	<ul style="list-style-type: none"> • Prefix.
	<ul style="list-style-type: none"> • DTMF Tone.
	<ul style="list-style-type: none"> • Direct pick up.
	<ul style="list-style-type: none"> • Group pick up.
	<ul style="list-style-type: none"> • Headset.
	<ul style="list-style-type: none"> • Group Listen.
	<ul style="list-style-type: none"> • Intercom.
	<ul style="list-style-type: none"> • Audio Hub.
	<ul style="list-style-type: none"> • XML Browser.
	<ul style="list-style-type: none"> • Phone Lock.











2.9 Status icons/ Call icons

Icons providing information about certain specific configurations on the phone or about the call status.

Status icons

Depending on the size of the display, all status icons may not be displayed simultaneously. Which icons are displayed depends on their priority. The following icons are listed according to their priority, from the highest to the lowest.

Status icons are displayed in the top bar of the screen.





	Silent mode.
	Telephone locked.
	Headset connected.
	Handsfree connected.
	Bluetooth ® accessory paired.
	Wi-Fi enabled.
	Interphony mode (Auto answer).
	Do not disturb.
	Audio Hub: PC not connected.
	Audio Hub: PC not connected.
	Updating in progress.

The call status is also displayed at the top of the call management screen:

- *Dial*: dial number.
- *Ringing*: Incoming calls.
- *Conversation*: In conversation.
- *On hold*: During a conversation, the contact is on hold.
- *Conference*: Conference mode with 2 contacts.

Call icons

Call icons are associated to a SIP account and are displayed at the level of the line key programmed in the home page. A text with call status is displayed in the top of the incoming call/conversation presentation screen.

	SIP account (idle state). A grayed or crossed icon means that the SIP account is not registered (Please contact your administrator). Line keys.
	Incoming call icon.
	Call in progress icon.
	Call on hold icon.





2.10 Alpha-numeric keyboard

Your phone is equipped with alphanumeric keyboard. You can switch between numeric keyboard to dial number, and alphabetic keyboard to enter text by pressing the corresponding preprogrammed key.

- Switch between the alphabetic and numeric keyboards:

<i>abc</i>	When you are in a text zone, you can switch to the alphabetic keyboard by selecting this key.
<i>123</i>	When alphabetic keyboard is activated, select this key to switch to the numeric keyboard.

- Enter alphabetic characters.
The number pad keys have letters that you can display by successive presses. The number is the last character in the series. Some special characters can be displayed by successively pressing the key:

	% \$ / ~ & () [] = *
	@ #
	space - _ 1
	+ . , ; : / \ ? ! 0



- Use navigation keys to move the cursor into the text.
- Bkspc* Use this key to delete the last entered character. The alphabetic mode remains activated.

2.11 Description of the connectors

Various connections to allow phone extensions. The type of connectors you have depends on your phone.

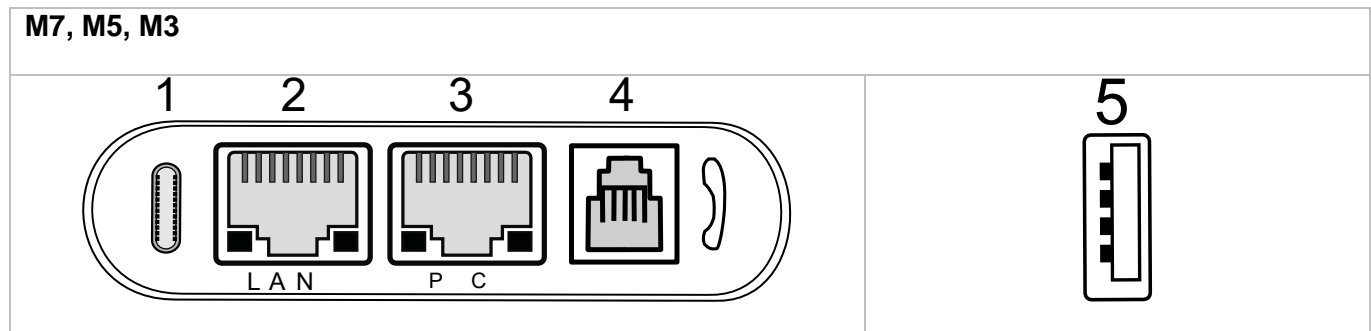

		M7	M5	M3	
1	Universal Serial Bus (USB-C) connector This connector is used for:				
	<ul style="list-style-type: none"> • Connect the power adapter. • Connect a headset. • Connect a PC to use the desk phone as an audio hub. 	●	●	●	
	2	10/100/1000 Mbps Ethernet connectors to the enterprise network (LAN - RJ45).	●	●	●
	3	10/100/1000 Mbps Ethernet connectors to a PC (RJ45).	●	●	●
4	Wired handset connector (RJ9).	●	●	●	
5	Universal Serial Bus (USB-a) connector. This connector is used for:				
	<ul style="list-style-type: none"> • Connect a USB headset. • Connect an add-on module. • Connect a Wi-Fi dongle*. • Connect a PC to use the desk phone as an audio hub. 	●	●	●	

*To know the supported dongle, please refer to the Alcatel-Lucent Enterprise website or contact your administrator.

3 Using your telephone

3.1 Information about the phone

The main page can display all SIP accounts used on the phone and other programmed keys. For each SIP account used on the phone, we recommend creating a programmed key to obtain information about account status. The icon associated to a SIP account provides the status of the account.



Information about new events such as missed calls and new voice message(s) are displayed in a pop-up on the main page. The message key flashes red when you have received a new voicemail or a missed an incoming call. When the new events pop-up is displayed, the blue LED of the phone flashes slowly.

3.1.1 More information about new events

	If the new events pop-up is not displayed, click on the message key to open it.
	Select the event to consult.

3.2 Making call

3.2.1 Open the dialer

This section describes how to make a call. There are different ways to open the dialer before calling your contact.

Use one of the following:	
	Dial directly the number for your call.
	Unhook the handset or the headset.
	Press the 'take the call' key.
	Press the loudspeaker/hands-free key.
	If the homepage displays an SIP account (line key), select the SIP account to use in order to make the call. This key has to be programmed in the homepage.

You can unhook the handset or the headset to make a call with the handset or the headset otherwise you make a call in hands-free mode.

3.2.2 Calling by number



	Open the dialer.
Use one of the following:	
	Dial the number.
	Select the contact to call in the list of last number dialed.
Use one of the following:	
	Press the 'take the call' key. Make the call with the active device: handset if unhooked, headset if connected, otherwise in hands-free mode.
	Press the OK key to start the call. Make the call with the active device: handset if unhooked, headset if connected, otherwise in hands-free mode.
<i>Call</i>	Press the call key to start the call. Make the call with the active device: handset if unhooked, headset if connected, otherwise in hands-free mode.
# or *	If defined in the phone settings, you can use these keys to initiate the call (<i>Menu</i> → <i>Features</i> → <i>Key As Send</i>).

Depending on the system, after dialing the number, the call can be started automatically after a delay without action.

When you are in hands-free mode, you can take the call at any time on the handset by unhooking it.



If your headset has no Off-hook/On-hook key, use the phone keys and switch on the audio on the

headset ().

To make an external call, dial the outside line access code before dialing your contact number. The call will start after a timeout of approx. 10 seconds if there is no action taken after dialling. If you are using multiple SIP accounts on your phone, you can choose which account to use to make the call.

3.2.3 Making a peer to peer SIP call

Your phone is compatible with the peer to peer SIP call. It is able to call phones connected to the same local network. You can call your contact by entering the IP address of your contact's desk phone. Make the call with the headset if connected, or in hands-free mode.

	Open the dialer.
Use one of the following:	
	Press the call key. Make the call with the active device: handset if unhooked, headset if connected, otherwise in hands-free mode.
	Press the OK key to start the call. Make the call with the active device: handset if unhooked, headset if connected, otherwise in hands-free mode.
<i>Call</i>	Press the call key to start the call. Make the call with the active device: handset if unhooked, headset if connected, otherwise in hands-free mode.
# or *	If defined in the phone settings, you can use these keys to initiate the call (<i>Menu</i> → <i>Features</i> → <i>Key As Send</i>).





The format of the entered IP address must be x.x.x.x or x*x*x*x where x is a decimal value between 0 and 255.

This feature is useful when you have no connection to a communication server (no registration, network problems, etc.). Not all the features are available should this occur and the phone's status should be displayed on the screen. This feature can be deactivated by your administrator.

3.2.4 Calling by name

You can call a contact by his/her name using the search feature in the company directory. This feature depends on the system configuration. If necessary, contact your administrator. You can unhook the handset or the headset to make a call with the handset or the headset otherwise you make a call in hands-free mode.



Use the alpha-numeric keyboard key to switch between the numeric and alphabetic keyboard.

	Open the dialer.
<i>abc</i>	Switch to the alphabetical keyboard.
	Enter the first letters of your contact's name. The search runs as soon as you enter a character (predictive search). The matching names are displayed.
	Select the contact to call.
Use one of the following:	
	Press the 'take the call' key. Make the call with the active device: handset if unhooked, headset if connected, otherwise in hands-free mode.
	Press the OK key to start the call. Make the call with the active device: handset if unhooked, headset if connected, otherwise in hands-free mode.
<i>Call</i>	Press the call key to start the call. Make the call with the active device: handset if unhooked, headset if connected, otherwise in hands-free mode.
# or *	If defined in the phone settings, you can use these keys to initiate the call (<i>Menu</i> → <i>Features</i> → <i>Key As Send</i>).

3.2.5 Call from call log

You can call back a contact from the call log.





You can unhook the handset or the headset to make a call with the handset or the headset otherwise you make a call in hands-free mode.

In idle state or from the dialer:	
<i>History</i>	Select this softkey to open call logs from the homepage or the dialer.
	Select the contact to call.
Use one of the following:	
	Press the 'take the call' key. Make the call with the active device: handset if unhooked, headset if connected, otherwise in hands-free mode.
	Press the OK key to start the call. Make the call with the active device: handset if unhooked, headset if connected, otherwise in hands-free mode.
<i>Call</i>	Press the call key to start the call. Make the call with the active device: handset if unhooked, headset if connected, otherwise in hands-free mode.
# or *	If defined in the phone settings, you can use these keys to initiate the call (<i>Menu</i> → <i>Features</i> → <i>Key As Send</i>).

If you are using multiple SIP accounts on your phone, the call back is made with the SIP account displayed in the call log.

3.2.6 Calling using your personal directory



You can unhook the handset or the headset to make a call with the handset or the headset otherwise you make a call in hands-free mode.

In idle state or from the dialer:	
<i>Directory</i>	Select this softkey to open your local directory from the homepage or the dialer.
	Open a directory (depending on model).
	Select the contact to call.
Use one of the following:	
	Press the 'take the call' key. Make the call with the active device: handset if unhooked, headset if connected, otherwise in hands-free mode.
	Press the OK key to start the call. Make the call with the active device: handset if unhooked, headset if connected, otherwise in hands-free mode.
<i>Call</i>	Press the call key to start the call. Make the call with the active device: handset if unhooked, headset if connected, otherwise in hands-free mode.
# or *	If defined in the phone settings, you can use these keys to initiate the call (<i>Menu</i> → <i>Features</i> → <i>Key As Send</i>).

If you are using multiple SIP accounts on your phone, you can choose which account to use to make the call.

3.2.7 Calling using speed dial key

You can unhook the handset or the headset to make a call with the handset or the headset otherwise you make a call in hands-free mode.











Select the key associated with the contact to call.

The SIP account used to make the call depends on the speed-dial key configuration.

3.3 Receiving a call

When receiving a call, you can:

	Lift the handset to take the call.
	Use the headset to take the call. If your headset has no Off-hook/On-hook key, use the phone keys and switch on the audio on the headset ().
	Press the loudspeaker/hands-free key to take the call in hands-free mode.
	Press the blinking line key associated with the SIP account receiving the call.
<i>Take call</i> or 	Take the call with the headset if connected, or in hands-free mode.
 or <i>Reject call</i>	Deflect the call to your voicemail.
<i>Silent</i>	Mute the ringer (the call is still incoming but the phone no longer rings).
<i>Deflect</i>	Deflect the call to another contact: Use one of the following: <ul style="list-style-type: none"> Using the up and down navigator (if necessary), find the contact to call. Enter the number or name of the contact to whom the call will be deflected.  Deflect the call to the selected contact.

3.4 Switching between audio modes

During the conversation, you can switch between different audio modes (handset, hands-free or headset, if connected) by pressing the loudspeaker/hands-free key until the desired audio mode is

displayed: . This feature depends on connected devices. The key is lit when the loudspeaker or hands-free mode is selected.

- You are in conversation with the handset, you can switch between following audio modes by short pressing on the loudspeaker/hands-free key.



- You are in conversation with the headset (headset or headset+loudspeaker), you can switch between following audio modes by short pressing on the loudspeaker/hands-free key.



- You can switch to loudspeaker (group listening mode with handset) when in conversation by pressing the group listening programmable key. First you have to create a group listening programmable key (see chapter: Programmable keys).



For each audio mode, during the conversation, you can adjust the volume by pressing the volume keys. The number of levels depends on the audio mode (8 for handset and headset 10 for hands-free and loudspeaker). The selected volume, for each audio mode, will be saved for future conversations.

- During a conversation.
- Adjust volume by pressing the volume keys.

3.5 Redialing

3.5.1 Call back the last number dialed

	long press: redialing the last number dialed.
--	---

3.5.2 Call back one of the last numbers dialed



	Short press: list of last numbers dialed.
	Select one of the last numbers dialed.
Use one of the following:	
	Press the 'take the call' key. Make the call with the active device: handset if unhooked, headset if connected, otherwise in hands-free mode.
	Press the OK key to start the call. Make the call with the active device: handset if unhooked, headset if connected, otherwise in hands-free mode.
<i>Call</i>	Press the call key to start the call. Make the call with the active device: handset if unhooked, headset if connected, otherwise in hands-free mode.

3.6 Contacts management

3.6.1 Contact card

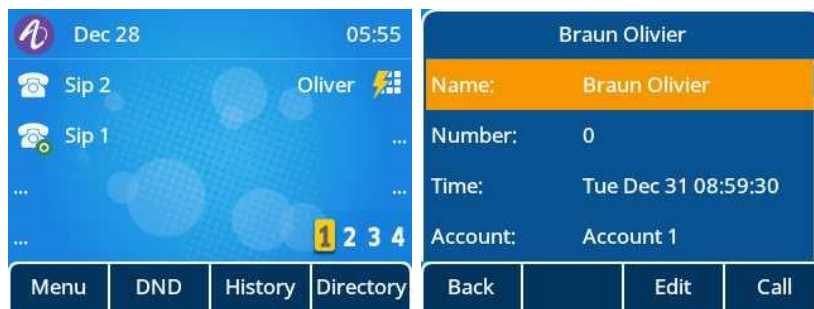
A contact card can be opened from your local directory.



<i>Directory</i>	Select this softkey to open your directory(-ies).
	Open a directory (depending on model).
	Select a contact.
<i>More → Detail</i>	Open the contact card.
	Use the up-down navigation keys to scroll the page.

The contact card displays information about the contact.

- Avatar: select an avatar for your contact by using right-left navigation keys.
- First name: first name of your contact.
- Last name: last name of your contact.
- Office: office number.
- Mobile: Mobile number.
- Other: Other number.
- Account: If you are using multiple SIP accounts, define which account is used to call this contact.
- Group: Define the group to which this contact belongs in order to make it easier to find.

From this page, you can:

	Modify information about your contact (avatar, name, add new number, etc.). Use the up-down navigation keys to edit a field.
---	---

3.6.2 Contacts management

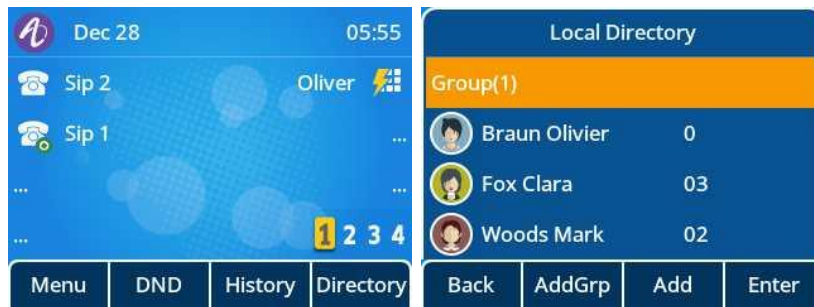

Your phone lets you manage contacts in your local directory. With the M7 DeskPhone, you can import contacts from your mobile phone to a specific directory (*External Directory*).

The directory is accessible from the homepage dynamic key or from the menu.

Use one of the following:

<i>Directory</i>	If configured, use the dynamic key from the home page to access to the directory(-ies) directly.
<i>Menu → Directory</i>	Select this softkey to open your directory(-ies).

In this user manual, we are using the dynamic key to access directory(-ies).

<i>Directory</i>	Select this softkey to open your directory(-ies). Depending on the model of your phone, your directory is composed of the local directory containing all contacts created on the phone and an external directory containing all imported contacts from your mobile phone (M7).
<i>Local Directory</i>	Open the local directory. Your local directory has displayed all saved contacts and groups. A group contains all contacts belonging to this group (defined in the contact card of the contact).
<i>External Directory</i>	Open the external directory. The external directory is only available on the M7 DeskPhone. Your external directory lists all contacts imported from your mobile phone via Bluetooth®.



From this page, you can:

<i>Search</i>	Search a contact in all directories and groups.
<i>Add</i>	Create a new contact.
<i>Delete</i>	Delete the selected contact.
<i>More</i>	Access more features.
<i>Call</i>	Call the selected contact.
<i>Detail</i>	Open the contact card.
<i>Delete all</i>	Delete all contacts in a directory.
<i>AddGrp</i>	Add a new group.
<i>Enter</i>	List contacts in the selected directory or group.
<i>Back</i>	Return to the main page.



3.6.3 Call your contact

<i>Directory</i>	Select this softkey to open your directory(-ies).
Use one of the following:	
<i>Search</i>	Search a contact in all directories and groups.
	Open a directory (depending on model).



To call your contact:

	Select the contact to call.
First method	
<i>More</i>	Access more features.
<i>Call</i>	Start the call.
Second method	
	Start the call.

If there are several numbers for the same contact, select the desired number.

	Select the desired number.
 or <i>Call</i>	Start the call.

3.6.4 Create a new contact in your local directory

<i>Directory</i>	Select this softkey to open your directory(-ies).
<i>Local Directory</i>	Open the local directory.
<i>Add</i>	Use the up-down navigation keys to switch from one input field to another.
<i>Switch</i> or 	<ul style="list-style-type: none"> Avatar: choose a predefined avatar. Account: if you are using multiple SIP accounts, define which account is used to call this contact. The default SIP account is selected by default. Group: define the group to which this contact belongs in order to make it easier to find. The group 'All contacts' is selected by default.
<i><Abc></i>	<ul style="list-style-type: none"> First name: enter first name of your contact. Last name: enter last name of your contact.
<i><123></i>	<ul style="list-style-type: none"> Office: enter the office number of your contact. Mobile: Enter the mobile number of your contact. Other: Enter another number.
 or <i>Save</i>	Your contact is added to the directory.

Other method:



- Add a contact from the history.

For external numbers, we recommend you use canonical address formats comprising '+', followed by the country code (e.g. '33') then the number without the first digit. For example, for 0390670000, enter the number +3390670000. To get the '+' sign, long press on the '0' key. This example is for calling a number in France from another country.



3.6.5 Create a new group

<i>Directory</i>	Select this softkey to open your directory(-ies).
<i>Local Directory</i>	Open the local directory.
<i>AddGrp</i>	Use the up-down navigation keys to switch from one input field to another.
<Abc><123>	Enter the name of the group.
 or <i>Save</i>	Your contact is added to the directory.



3.6.6 Modify a contact

<i>Directory</i>	Select this softkey to open your directory(-ies).
<i>Local Directory</i>	Open the local directory.
	Select the contact to modify.
<i>More</i>	Access more features.
<i>Detail</i>	
	Fill in the contact file. Use up-down navigation keys to edit a field.
 or <i>Save</i>	To save the contact in the local directory.



3.6.7 Delete a contact in a directory

<i>Directory</i>	Select this softkey to open your directory(-ies).
	Open a directory (depending on model).
	Use the up-down navigation keys to select the contact to delete.
<i>Delete</i>	
 or <i>Ok</i>	Confirm the deletion.



3.6.8 Delete all contacts in a directory

<i>Directory</i>	Select this softkey to open your directory(-ies).
<i>Local Directory</i>	Open the local directory.
	Use the up-down navigation keys to select a contact.
<i>More</i>	Access more features.
<i>Delete all</i>	
 or <i>Ok</i>	Confirm the deletion

3.6.9 Delete a group in the local directory

<i>Directory</i>	Select this softkey to open your directory(-ies).
<i>Local Directory</i>	Open the local directory.
<i>Group</i>	Access to all defined group(s).
	Select the group to delete.
<i>Delete</i>	Access to all defined group(s).
 or <i>Ok</i>	Confirm the deletion.

3.6.10 Delete all group in the local directory

<i>Directory</i>	Select this softkey to open your directory(-ies).
<i>Group</i>	
	Select the group to delete.
<i>Delete all</i>	
 or <i>Ok</i>	Confirm the deletion.

3.6.11 Import contacts from your mobile phone via Bluetooth® (M7)

To import a contact from your mobile phone you have to pair it to your desk phone. Before performing the pairing operation, the device must be in detectable mode. Consult the user documentation of your Bluetooth® device.

The phone is in idle state.

<i>Menu</i>	Press the Menu soft key to access the Main Menu.
<i>Basic Setting</i>	Use up-down and 'ok' navigation keys to select: <i>Basic Setting</i> .
<i>Bluetooth</i>	Use up-down and 'ok' navigation keys to select: <i>Bluetooth</i> .
<i>Scan</i>	Press the softkey under the following label: <i>Scan</i> . Scanning starts. Searching for Bluetooth® equipment. Wait for the detected equipment type and address to be displayed.
<i>Connect</i>	Add the device by pressing on the associated key: <i>Connect</i> .
	Enter the PIN code of the device if necessary.

This icon is displayed on your desk phone: .

Depending on your mobile phone, you have to accept to share contacts either during pairing or in connection options. Consult the user manual of your mobile phone.

The contacts are automatically imported into the directory: *External Directory*.

Contacts are kept until another mobile is connected to the M7 or if you delete all imported contacts manually.

If necessary, you can manually synchronize contacts:

The phone is in idle state.	
<i>Menu</i>	Press the Menu soft key to access the Main Menu.
<i>Basic Setting</i>	Use up-down and 'ok' navigation keys to select: <i>Directory</i> .
<i>Bluetooth</i>	Use up-down and 'ok' navigation keys to select: <i>Bluetooth</i> .
<i>Paired Bluetooth Device</i>	Use up-down and 'ok' navigation keys to select: <i>Paired Bluetooth Device</i> . The paired device is listed.
	Select your connected mobile phone.
<i>More</i> → <i>Enter</i> > <i>Sync BT Contacts</i>	Use up-down and 'ok' navigation keys to select: <i>Sync BT Contacts</i> . Synchronize the contacts.

3.7 Manage the call log (History)

The call log can be consulted and managed when the phone is in the idle state. The main part of the screen is used to display the call log.

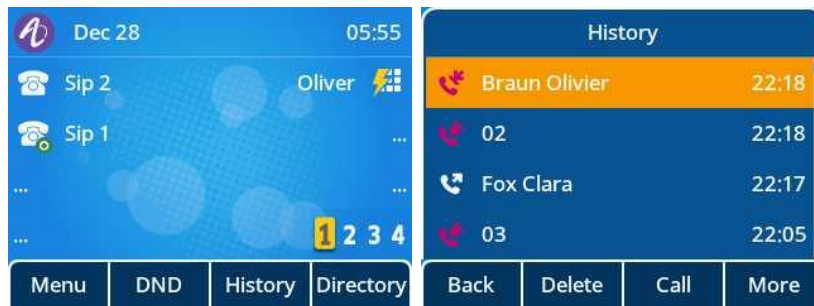











The call log (history) is accessible from the homepage dynamic key or from the menu.

Use one of the following:	
<i>History</i>	If configured, use the dynamic key from the home page to access to the call log directly.
<i>Menu</i> → <i>History</i>	Use the menu key to access the call log.

In this user manual, we are using the dynamic key to access the call log.



All call logs associated with the selected contact are displayed with an icon showing the type of call.

		Answered incoming calls.
		Unanswered incoming calls.
		Unanswered incoming call that has been acknowledged.
		Answered outgoing calls.
		Unanswered outgoing calls.

Actions are available from the call log:

<i>Delete</i>	Delete the selected entry. Note that no confirmation is requested.
<i>Call</i>	Call the selected contact.
<i>More</i>	Access more features.
 or <i>Detail</i>	Open information about the contact: name, number, time, relevant SIP account, duration.
<i>Delete all</i>	Delete the entire log associated with the selected contact. Note that no confirmation is requested.
<i>Missed</i>	Display missed calls only.
<i>AddClist</i>	Add the contact in your local directory. If the contact already exists, the contact card is edited.
<i>Back</i>	Return to the main page.

3.7.1 Call the contact

<i>History</i>	Select this softkey to open call logs from the homepage or the dialer.
	Select the contact to call.
Use one of the following:	
	Press the 'take the call' key. Make the call with the active device: handset if unhooked, headset if connected, otherwise in hands-free mode.
	Press the OK key to start the call. Make the call with the active device: handset if unhooked, headset if connected, otherwise in hands-free mode.
<i>Call</i>	Press the call key to start the call. Make the call with the active device: handset if unhooked, headset if connected, otherwise in hands-free mode.

3.7.2 Display missed calls only

<i>History</i>	Select this softkey to open call logs from the homepage or the dialer.
<i>Missed</i>	Press this key to display missed calls only.

3.7.3 Acknowledge all new missed call logs

All missed calls are acknowledged as soon as you consult the call log (history).

3.7.4 Delete a contact in the call log

<i>History</i>	Select this softkey to open call logs from the homepage or the dialer.
	Select the contact to delete.
<i>Delete</i>	Delete the selected entry. Note that no confirmation is requested.

3.7.5 Clear the call log

<i>History</i>	Select this softkey to open call logs from the homepage or the dialer.
<i>More</i>	Access more features.
<i>Delete all</i>	
 or <i>Ok</i>	Confirm the deletion.

If you are using multiple SIP accounts on your phone, the concerned SIP account is displayed for each entry of the call log ( or *Detail*).

3.8 Speed dial management

Speed dial lets you manage favorite contacts. You can create speed dial keys by programming keys from the homepage.





3.8.1 Create a speed dial key



Use one of the following:

	Long press on a free programmable key.
<i>Menu -> Features -> Programmable Key</i>	Use up-down and 'ok' navigation keys to select: <i>Programmable Key</i> .

Create a speed dial key.

<i>Switch</i> or 	Define the type of programmable key: <i>Speed dial</i> .
<i>Account</i>	Associate a SIP account to use to make the call.
<i><123><Abc></i>	Enter the number and its label.
 or <i>Save</i>	Save the speed dial key.

3.8.2 Make call using speed dial



	 Select the key associated with the contact to call.
---	---

3.9 Sending DTMF signals

During a conversation you sometimes have to send DTMF signals, such as with a voice server, an automated attendant or a remotely consulted answering machine.

	Enter DTMF code.
---	------------------

To activate or deactivate DTMF mode

The phone is in idle state.	
<i>Menu</i>	Press the Menu soft key to access the Main Menu.
<i>Basic Setting</i>	Use up-down and 'ok' navigation keys to select: <i>Basic Setting</i> .
<i>Sound</i>	Use up-down and 'ok' navigation keys to select: <i>Sound</i> .
<i>DTMF Tone</i>	Use up-down and 'ok' navigation keys to select: <i>DTMF Tone</i> .
<i>Switch</i> or 	To activate or deactivate DTMF mode.
 or <i>Save</i>	Validate your choice.
	To end the settings.

3.10 Mute, so that your contact cannot hear you





You can hear your contact but he/she cannot hear you:

During a conversation.	
	Disable microphone >>  the key lights up.
	Resume the conversation >>  the key is no longer lit.

3.11 Interphony (auto answer)

In the interphony mode, calls are automatically answered.

Activate the interphony:

The phone is in idle state.	
<i>Menu</i>	Press the Menu soft key to access the Main Menu.
<i>Features</i>	Use up-down and 'ok' navigation keys to select: <i>Features</i> .
<i>Auto answer</i>	Use up-down and 'ok' navigation keys to select: <i>Auto answer</i> .
	Select the SIP account. All incoming calls to this SIP account will be auto answer.
<i>Switch</i> or 	Enable the interphony.
 or <i>Save</i>	Save the setting.
	This icon is displayed in the status bar.

3.12 Make an intercom call



When you make an intercom call, the call is automatically picked-up by your contact, if intercom is enabled on your contact's phone. The ring tone will then be different.

To make an intercom call, you have to create a programmed key: *Intercom*.

- *Account*: select the relevant SIP account.
- *Label*: enter the label of the key, displayed on the home page.
- *Value*: Enter the contact number to call.

3.13 Configure the intercom incoming calls





When you receive an intercom call, the desk phone automatically answers the call if you have authorized the option. You can manage your desk phone behavior when you receive an intercom call.

The phone is in idle state.	
<i>Menu</i>	Press the Menu soft key to access the Main Menu.
<i>Features</i>	Use up-down and 'ok' navigation keys to select: <i>Features</i> .
<i>Intercom</i>	Use up-down and 'ok' navigation keys to select: <i>Intercom</i> .
	Select the SIP account. All incoming calls to this SIP account will be auto answer.
<i>Switch</i> or 	<ul style="list-style-type: none"> • <i>Allow</i>: enable/disable intercom call. • <i>Mute</i>: enable/disable mute. • <i>Tone</i>: enable/disable tone. • <i>Barge</i>: enable/disable barge.
 or <i>Save</i>	Save the setting.

3.14 Change PIN code



The PIN code is requested to unlock the phone.

The default PIN code is: 0000.

The phone is in idle state.	
<i>Menu</i>	Press the Menu soft key to access the Main Menu.
<i>Basic Setting</i>	Use up-down and 'ok' navigation keys to select: <i>Basic Setting</i> .
<i>Change PIN</i>	Use up-down and 'ok' navigation keys to select: <i>Change PIN</i> .
	Enter current PIN code.
	Enter the new PIN code.
	Confirm new PIN code.
 or <i>Save</i>	Save the setting.
	To end the settings.

3.15 lock / unlock your telephone



Enable the phone lock.

The phone is in idle state.	
<i>Menu</i>	Press the Menu soft key to access the Main Menu.
<i>Basic Setting</i>	Use up-down and 'ok' navigation keys to select: <i>Basic Setting</i> .
<i>Phone Lock</i>	Use up-down and 'ok' navigation keys to select: <i>Phone Lock</i> .
<i>Switch</i> or 	Enable the option: <i>Lock Enable</i> .
	
	To end the settings.

To lock/unlock your desk phone, you have to create a programmed key: *Phone Lock*.

- *Label*: enter the label of the key, displayed on the home page.

3.15.1 Lock your phone





	Select the lock/unlock programmed key.
<i>Ok</i> / 	Validate your choice. Your phone is locked. A lock page is displayed.

You can only call emergency numbers, such as 'Operator' or 'Guard', once the phone is locked (max 3 numbers, configured by the administrator).

3.15.2 Unlock your phone

	Unlocking your phone. Your password is required to unlock the phone (the default PIN code is: 0000).
---	--

3.15.3 Activate or deactivate the automatic keypad lock

The phone is in idle state.	
<i>Menu</i>	Press the Menu soft key to access the Main Menu.
<i>Basic Setting</i>	Use up-down and 'ok' navigation keys to select: <i>Basic Setting</i> .
<i>Phone Lock</i>	Use up-down and 'ok' navigation keys to select: <i>Phone Lock</i> .
<i>Switch</i> or 	Enable the option: <i>Auto Lock Enable</i> .
	Enter the timeout without activity before the keylock (seconds).
 or <i>Save</i>	Validate your choice.
	To end the settings.

3.16 During conversation

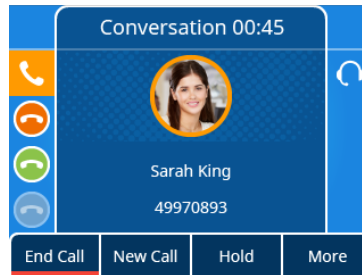

Actions available during conversation:





<i>End</i>	End the call.
<i>Hold</i>	Placing a call on hold.
<i>Transfer</i>	Transfer a call.
<i>Retrieve</i>	Retrieve a call (on hold, parked).
<i>New</i>	Make a second call when the first is on hold.
<i>Swap</i>	Switching between calls.
<i>Conf</i>	Establishing a three-party conference call.
<i>End conf</i>	End the conference with all participants.

3.17 Making a second call during a conversation

During a conversation.

<i>Hold</i>	Your first call is placed on hold.
<i>New</i>	A dial area and the call log are displayed.





Use one of the following:

	Enter the number.
	Select a contact in the call log.
<i>Directory</i> →  or <i>Call</i>	Call a contact from the local directory.
<abc> →  or <i>Call</i>	Call your contact using the dial-by-name function.
	Select the 'Redial' function.

3.18 Answering a second call during a conversation

	During a conversation, another person is trying to call you. You are alerted with 3 beeps. The identity of the caller is displayed as long as the call is presented on your phone. The key in front of the SIP account receiving the call is blinking.
--	--

Use one of the following:

	Press the blinking line key associated with the SIP account receiving the call.
<i>Take call</i> or 	Take the call with the headset if connected, or in hands-free mode.
 or <i>Reject call</i>	Deflect the call to your voicemail.
<i>Silent</i>	Mute the ringer (the call is still incoming but the phone no longer rings).
<i>Deflect</i>	Deflect the call to another contact: Use one of the following: <ul style="list-style-type: none"> ○ Using the up and down navigator (if necessary), find the contact to call. ○ Enter the number or name of the contact to whom the call will be deflected.  Deflect the call to the selected contact.

As long as the call is presented, you can also choose to deflect the call.

3.19 To cancel your second call and recover the first

You are in conversation with the second contact and the first one is on hold.

Use one of the following:

	You or the second contact hangs up.
<i>End</i>	Press the softkey under the following label: <i>End</i> .
Recover the call on hold:	
<i>Retrieve</i>	Press the softkey under the following label: <i>Retrieve</i> . You are on the line with your first contact.

3.20 Placing a call on hold (hold)



During a conversation, you wish to place the call on hold and recover it later, on the same telephone. Place the call on hold:

Use one of the following:

	Press the hold key.
<i>Hold</i>	Press the softkey under the following label: <i>Hold</i> .

Recover the call on hold:



Use one of the following:

	Press the hold key.
<i>Retrieve</i>	Press the softkey under the following label: <i>Retrieve</i> .
	Press the dedicated account key with call-on-hold icon.

3.21 Switching between calls (Broker call)

During a conversation, a second call is on hold.

Use one of the following:

<i>Swap</i>	Press the softkey under the following label: <i>Swap</i> .
	Press the hold key.
	Press the dedicated account key with call-on-hold icon.

» You can talk to the first caller and the second one is on hold.

3.22 Transferring a call

3.22.1 To transfer a call to another contact on hold

During a conversation, a second call is on hold.

Use one of the following:

	Press the transfer key » the two callers are connected.
<i>Transfer</i>	Press the softkey under the following label: <i>Transfer</i> » the two callers are connected.

3.22.2 To transfer your call to another number

During a conversation.

Use one of the following:

	Press the transfer key » the first call is on hold.
<i>Transfer</i>	Press the softkey under the following label: <i>Transfer</i> » the first call is on hold.

<i>New -></i>  or <i>Call</i>	Call the recipient of the transfer using the dial a number or dial by name feature or the call log or local directory. Your contact answers.
--	---



Use one of the following:

	Press the transfer key » the two callers are connected.
<i>Transfer</i>	Press the softkey under the following label: <i>Transfer</i> » the two callers are connected.

Transfer between two outside calls is not generally possible (depends on country concerned and system configuration).

3.22.3 Blind transfer

You can also transfer your call immediately, without having to wait for your contact to answer.

During a conversation.	
Use one of the following:	
	Press the transfer key »» the first call is on hold.
<i>Transfer</i>	Press the softkey under the following label: <i>Transfer</i> »» the first call is on hold.
<i>New -></i>  or <i>Call</i>	Call the recipient of the transfer using the dial a number or dial by name feature or the call log or local directory.
<i>B transt</i>	Before your contact answers the call, select <i>B transt</i> »» the two callers are connected.

Transfer between two outside calls is not generally possible (depends on country concerned and system configuration).

3.23 Three-way conference

During a conversation, a second call is on hold.	
Use one of the following:	
	Press the conference key »» you are in conference mode.
<i>Conf</i>	Press the softkey under the following label: <i>Conf</i> »» you are in conference mode.

3.23.1 End the conference with all participants



You are in conference mode.	
Use one of the following:	
	Press the on-hook key »» the conference is ended.
<i>End conf</i>	Press the softkey under the following label: <i>End conf</i> »» the conference is ended.

3.23.2 After the conference, to leave your two contacts talking together

You are in conference mode.	
Use one of the following:	
	Press the transfer key »» the two participants remain on the call together.
<i>Transfer</i>	Press the softkey under the following label: <i>Transfer</i> »» the two participants remain on the call together.

3.24 Talk simultaneously to more than 2 contacts (five-way conference with internal contacts) (M7, M5)

This feature is available only for the following device: M7 DeskPhone, M5 DeskPhone.

You are in three-way conference call.	
Use one of the following:	
	Press the hold key.
<i>Hold</i>	Press the softkey under the following label: <i>Hold</i> .
<i>New -></i>  or <i>Call</i>	Call a new participant by using the dial a number or dial by name feature or the call log or local directory. You are in conversation with the new participant.
<i>Join</i>	The new participant is joining the conference call.

When the maximum of participants is reached, you will not be able to make a new call to add a new participant.





3.24.1 End the conference with all participants

You are in conference mode.	
Use one of the following:	
	Press the on-hook key >> the conference is ended.
<i>End conf</i>	Press the softkey under the following label: <i>End conf</i> >> the conference is ended.

If you are a participant (you did not initiate the conference call), you can exit the conference by pressing the on-hook key.





3.25 Hide your phone number

you can choose to hide your identity when calling.

	The phone is in idle state.
<i>Menu</i>	Press the Menu soft key to access the Main Menu.
<i>Features</i>	Use up-down and 'ok' navigation keys to select: <i>Features</i> .
<i>Anonymous</i>	Use up-down and 'ok' navigation keys to select: <i>Anonymous</i> .
	Select the SIP account whose phone number will be hidden.
<i>Switch</i> or 	Enable the option: <i>Anonymous</i> .
 or <i>Save</i>	Validate your choice.
	To end the settings.



>> your identity will be hidden.

3.26 Reject anonymous calls

The phone is in idle state.	
<i>Menu</i>	Press the Menu soft key to access the Main Menu.
<i>Features</i>	Use up-down and 'ok' navigation keys to select: <i>Features</i> .
<i>Anonymous rejection</i>	Use up-down and 'ok' navigation keys to select: <i>Anonymous rejection</i> .
	Select the SIP account to reject anonymous calls.
<i>Switch</i> or 	Enable the option: <i>Anonymous rejection</i> .
 or <i>Save</i>	Validate your choice.
	To end the settings.

3.27 Do not disturb

You can make your terminal temporarily unavailable for all calls.

The phone is in idle state.	
<i>Menu</i>	Press the Menu soft key to access the Main Menu.
<i>Features</i>	Use up-down and 'ok' navigation keys to select: <i>Features</i> .
<i>DND</i>	Use up-down and 'ok' navigation keys to select: <i>DND</i> .
<i>Switch</i> or 	Enable the option: <i>DND</i> .
 or <i>Save</i>	Validate your choice.
	To end the settings.

To deactivate the Do not disturb feature, follow the same procedure.



To have a direct access to this feature, program a key on the home page (see chapter: Programmable keys).

From the Web Management, it is possible to enable/disable the feature for all accounts declared on the phone (the administrator password of the phone is requested).

3.28 Forwarding to a number

When you are absent or already in communication (all lines are busy), all your calls are forwarded to the defined number. You can define a programmed key to activate forward.

The phone is in idle state.	
<i>Menu</i>	Press the Menu soft key to access the Main Menu.
<i>Features</i>	Use up-down and 'ok' navigation keys to select: <i>Features</i> .
<i>Call Forward</i>	Use up-down and 'ok' navigation keys to select: <i>Call Forward</i> .
Select the type of call forwarding required	
<i>Always Forward</i>	All your calls are immediately forwarded to another number.
<i>Busy Forward</i>	All your calls are forwarded to another number when you are already on the line.
<i>No Answer Forward</i>	All your calls are forwarded to another number when you cannot answer.

<i>Switch</i> or 	Activate the forward.
<i>Forward To</i>	Enter the destination number.
 or <i>Save</i>	Validate your choice.
	To end the settings.

To have a direct access to this feature, program a key on the home page (see chapter: Programmable keys).



We recommend using programmed key on the home page to find the status of the phone easily. If a feature is activated, the corresponding key is lights up.

From the Web Management, it is possible to enable/disable the feature for all accounts declared on the phone (the administrator password of the phone is requested).

3.29 Cancelling all forwards

If you are using a programmed key, just press it.



The phone is in idle state.	
<i>Menu</i>	Press the Menu soft key to access the Main Menu.
<i>Features</i>	Use up-down and 'ok' navigation keys to select: <i>Features</i> .
<i>Call Forward</i>	Use up-down and 'ok' navigation keys to select: <i>Call Forward</i> .
Select the type of call forwarding to cancel.	
<i>Always Forward</i>	All your calls are immediately forwarded to another number.
<i>Busy Forward</i>	All your calls are forwarded to another number when you are already on the line.
<i>No Answer Forward</i>	All your calls are forwarded to another number when you cannot answer.

<i>Switch</i> or 	Deactivate forward.
 or <i>Save</i>	Validate your choice.
	To end the settings.

3.30 Listen to your voicemail

This feature depends on the system configuration. If necessary, contact your administrator.

The message key flashes when you have received a new voicemail or if you have missed calls.



	Press the messaging key. Number of messages received is displayed.
<i>X new voice message(s)</i>	Use up-down and 'ok' navigation keys to access voicemail.
	The number of new messages is displayed for each registered account. Select the relevant account.
 or <i>Enter</i>	Call your voicemail. Follow the instructions from the voicemail server.

You can use the menu to access voicemail: *Menu* → *Voicemail* → *View Voicemail*.

3.31 Defining a 'hotline' number

If configured, the 'hotline' number is dialed immediately or after a time delay when you take the line by picking up the handset, by pressing the hands-free button or pressing the call button of the headset.

To configure the 'hotline' number:

The phone is in idle state.	
<i>Menu</i>	Press the Menu soft key to access the Main Menu.
<i>Features</i>	Use up-down and 'ok' navigation keys to select: <i>Features</i> .
<i>Hotline</i>	Use up-down and 'ok' navigation keys to select: <i>Hotline</i> .
<i>Number</i>	enter the number of the 'hotline'.
<i>Delay</i>	Enter the time delay in seconds before the 'hotline' number is dialed, if no action is performed during this time (0 – 10s). The 'hotline' number is immediately dialed if the delay time is set to 0s.
<i>Switch</i> or 	Enable the feature.
 or <i>Save</i>	Validate your choice.
	To end the settings.

Follow the same procedure to deactivate the feature.

This feature can be configured via the Web Management.

4 Do more with your desk phone

Your desk phone is designed to evolve with its environment. It can do more than just establish communication between people or keep in touch with your contacts, your enterprise. This chapter describes some use-cases with your phone.

4.1 Use your desk phone as a USB audiohub for your computer

Your phone can be used as an external audio playback/recording device for your personal computer (PC). Use the hands-free mode of your desk phone with applications such as Rainbow, OpenTouch Conversation for PC, Skype, etc. Or you can simply listen to music with an outstanding audio performance.

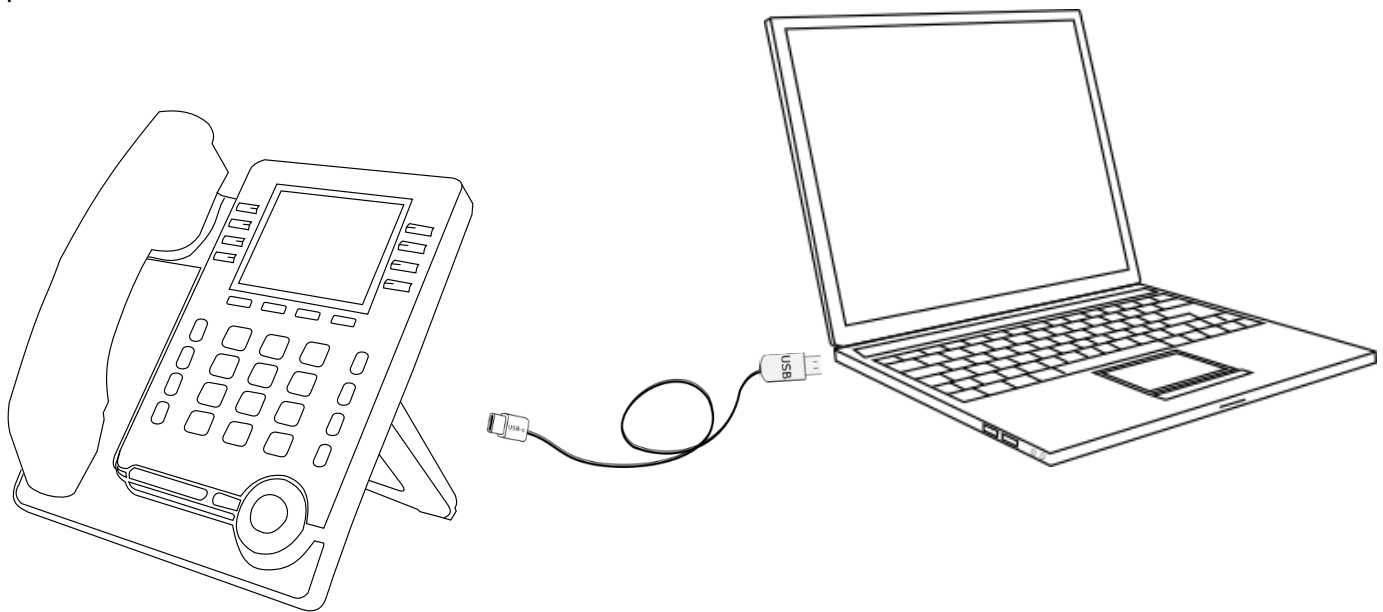

4.1.1 Installation

4.1.1.1 Prerequisites

Before using your DeskPhone as a USB audiohub for your computer, make sure your computer meets the minimum hardware and software requirements:

The lists below are for information only and are not contractual. Contact your administrator if necessary.

- The supported operating systems are:





Windows	Mac OS X	Linux
7 (32-bit or 64 bit) 8 (32-bit or 64 bit) 8.1 (32-bit or 64 bit) 10 (32-bit or 64 bit)	10.9 (Maverick) 10.10 (Yosemite) 10.11 (El Capitan) 10.12 (Sierra), 10.13 (High Sierra), 10.14 (Mojave), 10.15 (Catalina)	Compatible with most Linux distributions.



- USB connector: we recommend a USB 3.0 port (USB 2.0 or 1.0 port can reduce performance).
- We recommend using the latest version of audio applications or web browser.

4.1.1.2 Connect your computer to your desk phone

You can use a USB-A or USB-C connectors of the DeskPhone to connect the PC. A stand-alone USB cable is not provided with your set.

- Configure your desk phone to use it as an audiohub.

The phone is in idle state.	
<i>Menu</i>	Press the Menu soft key to access the Main Menu.
<i>Basic Setting</i>	Use up-down and 'ok' navigation keys to select: <i>Basic Setting</i> .
<i>Usb</i>	Use up-down and 'ok' navigation keys to select: <i>Usb</i> .
	Select the USB port you are using to connect the PC (USB-A, USB-C).
<i>Switch</i> or 	Select the mode: <i>Slave</i> .
 or <i>Save</i>	Validate your choice.
	To end the settings.

- Create the programmable key: *Audio Hub* (see chapter: Programmable keys). The programmable key allows you to control the audio on the phone (pause, play). As long as the PC is not connected, the following icon is displayed in front of the programmable key and on the status bar: .
- Connect your computer to the USB-A or USB-C connector of your desk phone with the USB cable (not provided). The phone is recognized as a sound device on computer (for example 'Echo cancelling speakerphone' with Windows). The following icon is displayed in front of the programmable key and on the status bar: .

4.1.1.3 Set the default audio device for Windows

In most cases, your desk phone is ready to be used when connected to your computer. However, it is sometimes necessary to manually configure the playback and recording default device. The configuration depends on the operating system of the connected computer. Consult the user manual of the operating system of your computer.

4.1.1.3.1 Windows

- Open the sound control panel from the Windows configuration panel or the sound icon in the Windows notification area.

- In the 'Playback' tab: Select your desk phone as the default device.

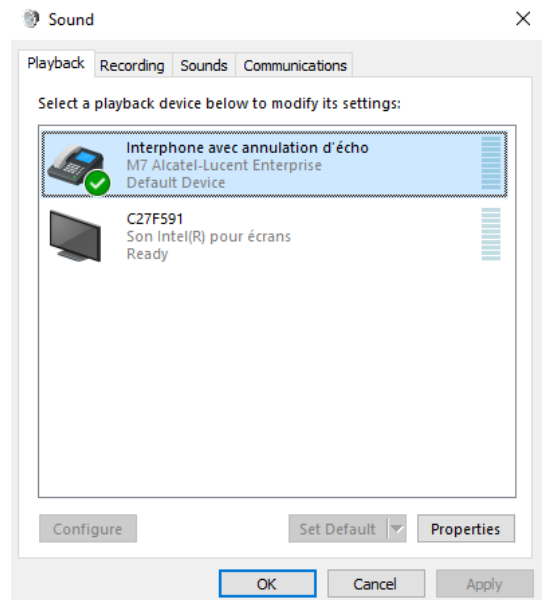
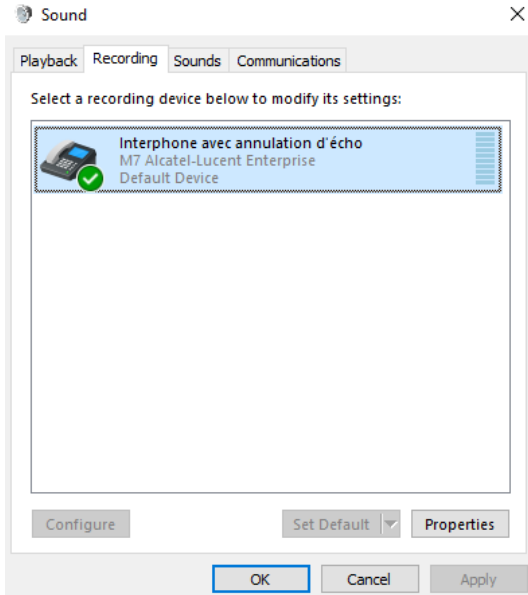

- In the 'Recording' tab: select your desk phone as the default device, if you are using the hands-free mode of your desk phone with communication applications such as Rainbow, OpenTouch Conversation for PC, for example.

- Activating/Deactivating the sounds

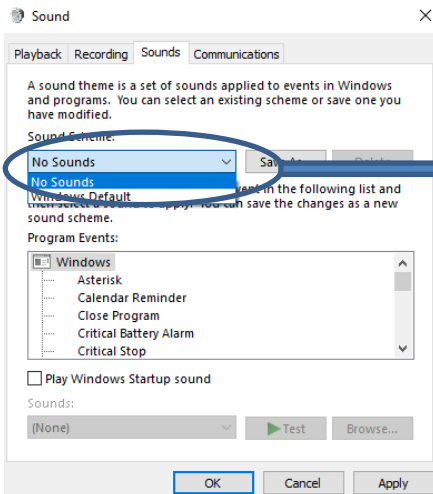

If you set your desk phone as the default audio device, all of the sounds from your computer are played on your desk phone, like notifications.

1. Activating/Deactivating the sounds.
2. Apply.

Consult the user manual of the operating system of your computer.

4.1.1.3.2 Mac OS 10.9 and above

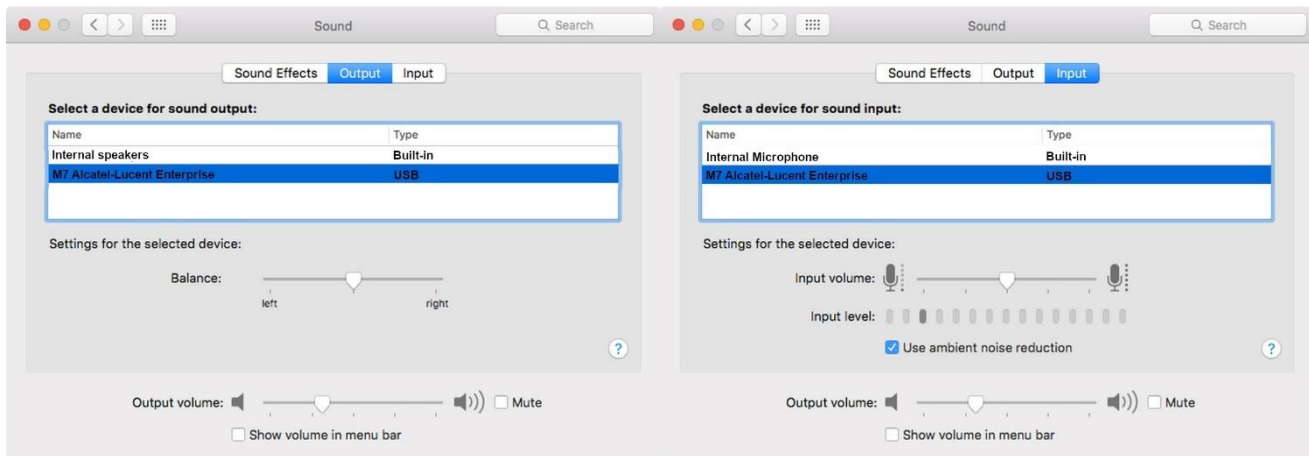

- Open System Preferences -> Sound.
- Select your desk phone in output and input tabs:



4.1.2 Using your phone as an audio hub

When audio starts playing on the PC, it will also be played on the phone.

The audio hub programmable key lets you control the playback:

	<p>The audio is playing on the phone. Pause the audio by pressing the programmable key.</p>
	<p>Play/resume the audio by pressing the programmable key.</p>

The volume can be adjusted on the phone by using volume keys or via the PC.

You can use the hands-free mode of your desk phone with communication applications such as Rainbow, OpenTouch Conversation for PC, for example.

The audio is paused when you receive an incoming call or perform any other operation on the phone that is not related to the audio hub. You can resume the audio at any time by pressing the audio hub programmable key.

4.2 Configure your phone for remote working

Your IP phone is compatible with remote working (VPN) via a secure connection (encrypted). A Virtual Private Network (VPN) is a technology that allows a device to create a tunneling connection to a server and becomes part of the enterprise's network (VPN server's network). VPN tunnels are secured with OpenVPN protocol with TLS authentication, credentials and certificates.

To establish an VPN connection, make sure you have information about connection from the hosting provider:

- Connection settings: server address, port and protocol.
- CA root certification file (.crt).
- Client certification file (.crt).
- Client key file (.key).

The VPN connection must be configured, started and stopped from the Web Management device.

- Open the Web Management device.
When the phone is connected to the network, your administrator can access the Web Management via a web browser by entering the IP address of your phone. The administrator password of the phone is requested.

- In the settings tab, select the VPN menu (OpenVPN).
- Enter the required information (VPN server address, port and protocol).
- Upload security files: choose a file and select the upload button for each file (CA root certification, Client certification, Client key file).
- Enable VPN.
- Apply.
- The desk phone restarts.

The connection will be established every time the system reboots until you disable the VPN manually. To disable the VPN:

- Open the Web Management device.
- In the settings tab, select the VPN menu (OpenVPN).
- Disable the VPN.
- Enable VPN.
- Apply.
- The desk phone restarts.

4.3 Connect your phone to the Wi-Fi









It is possible to connect your DeskPhone to the wireless network of your company or at your home, in case of remote worker (VPN). You have to plug a Wi-Fi dongle into the USB-A connector of your phone: To know the supported dongle, please refer to the Alcatel-Lucent Enterprise website or contact your administrator. The dongle can use 2.4Ghz and 5Ghz bands, but we recommend using a 5Ghz Wi-Fi network to ensure the best audio quality. The best radio signal will be automatically selected. A specific icon is displayed in the status bar when you are connected to a Wi-Fi access point: .

4.3.1 Configure the wireless network

You can manually configure your DeskPhone to connect to the selected Wi-Fi access point (SSID). This section is useful when you connect your phone to your personal Wi-Fi network for teleworking or to check the Wi-Fi configuration of the phone. Before configuring your phone, you need to know the name and the network security key (passphrases) of the Wi-Fi access point.

Plug the Wi-Fi dongle into the USB-A connector of the DeskPhone.
Start your desk phone (powered by PoE or adapter).

The phone is in idle state.

<i>Menu</i>	Press the Menu soft key to access the Main Menu.
<i>Advanced Setting</i>	Use up-down and 'ok' navigation keys to select: <i>Advanced Setting</i> . The administrator password of the phone is requested. Enter the administrator password. Validate.
<i>Wi-Fi</i>	All scanned SSIDs are listed according to signal strength (it may take a few seconds to display the available networks). Use the up-down navigation key to scroll the page.  : this icon, displayed at left of the SSID name, represents the signal strength: the more waves, the better the signal. During connection establishment, this icon is displayed at right of the SSID name.  : this icon indicates the current connected SSIDs.  : this icon indicates SSIDs already saved in the phone.
 or <i>Detail</i>	Display all information about the corresponding wireless network, such as the SSID, encryption mode, channel, signal strength.
<i>Connect</i>	Connect the phone to the selected wireless network.
	If the wireless network is not already saved, enter the network security key (passphrase) if requested. Use the alpha-numeric keyboard key to switch between the numeric and alphabetic keyboard.  : during connection establishment, the Wi-Fi icon is displayed (1 to 4 waves).
	If the connection is successful, a pop-up is displayed on your phone. A specific icon is displayed in the status bar when you are connected to a Wi-Fi access point:  . The SSID and authentication is automatically saved, if it has not already been saved.

To switch back to the wired network, unplug the Wi-Fi dongle, connect the Ethernet cable and restart the desk phone.

4.3.2 Manage wireless network

The Wi-Fi manager allows you manage all saved wireless network configurations on your phone. If the wireless network is available and saved on your phone, the connection is automatic. If there are several networks available, the best signal will be used.

4.3.2.1 Open the Wi-Fi manager

The phone is in idle state.

<i>Menu</i>	Press the Menu soft key to access the Main Menu.
<i>Advanced Setting</i>	Use up-down and 'ok' navigation keys to select: <i>Advanced Setting</i> . The administrator password of the phone is requested. Enter the administrator password. Validate.
<i>Wi-Fi → Wi-Fi Manager</i>	Use up-down and 'ok' navigation keys to select: <i>Wi-Fi Manager</i> .



4.3.2.2 Add a new wireless network

Open the Wi-Fi manager.

<i>Add</i>	Depending on the Wi-Fi network, enter the SSID, security mode, encryption mode and password of the wireless network. Use the alpha-numeric keyboard key to switch between the numeric and alphabetic keyboard.
<i>Save</i>	Save the wireless network.

4.3.2.3 Modify a saved wireless network

Open the Wi-Fi manager.

	Use up-down navigation keys to select the saved wireless network to edit.
 or <i>Edit</i>	Depending on the Wi-Fi network, enter the SSID, security mode, encryption mode and password of the wireless network. Use the alpha-numeric keyboard key to switch between the numeric and alphabetic keyboard.
<i>Save</i>	Save the wireless network.

4.3.2.4 Remove a saved wireless network

Open the Wi-Fi manager.

	Use up-down navigation keys to select the saved wireless network to delete.
<i>Delete</i>	Delete the selected wireless network.

4.4 Desk sharing

The availability of this feature depends on your system and its configuration. Please contact your administrator before using these services.

This feature allows you to use any compatible SIP DeskPhone in your company with your own phone number. When you activate your account on a desk phone, you retrieve your entire phone configuration: local directory, history (depending on the system configuration). After reboot the phone restarts with its initial configuration.

We recommend activating only one phone number at a time to ensure that all incoming calls are received on the same phone.



This feature has to be activated by the administrator of the phone.

Before using this feature, you have to program a key on the home page with the following feature: *Hot Desking*.

- o *Label*: enter the label of the key, displayed on the home page.

4.4.1 Login to desk sharing

When you start the desk sharing feature, all user configurations on the phone are cleared.

	Select the desk sharing programmed key.
Ok	Validate to ensure all current user configurations will be cleared.
	Enter the phone number and password of the SIP account.
 or Save	Confirm. The desk phone is loading the Sip account configuration. You can use it as your own desk phone.

4.4.2 Logout of desk sharing

When you want to leave the office and retrieve the initial state of the phone, you have to reboot the phone.

4.5 Third-Party Call Control (3PCC) with Rainbow application

This feature depends on the system configuration. If necessary, contact your administrator.



Your phone is compatible with third-party call control to manage calls (basic features) from your computer via the Alcatel-Lucent Rainbow application:

- Make and answer calls.
- Put your contact on hold or retrieve.
- Transfer a call.
- Consultation and configuration of the mail box (if defined).



Please consult the Rainbow support site for more information: <https://support.openrainbow.com/hc/>.

5 Programming your telephone

5.1 Adjusting the audio functions

These features can be configured via the Web Management.



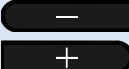

5.1.1 Select the melody

The phone is in idle state.	
<i>Menu</i>	Press the Menu soft key to access the Main Menu.
<i>Basic Setting</i>	Use up-down and 'ok' navigation keys to select: <i>Basic Setting</i> .
<i>Sound</i>	Use up-down and 'ok' navigation keys to select: <i>Sound</i> .
<i>Ringing</i>	Use up-down and 'ok' navigation keys to select: <i>Ringing</i> .
<i>Ext. Melody/Int. Melody</i>	The melody must be chosen for external and internal calls: <i>Ext. Melody/Int. Melody</i> (optional).
	Select the melody of your choice (16 tunes).
 or <i>Enter</i>	Validate your choice.
	To end the settings.



5.1.2 Adjusting the ringer volume

The phone is in idle state.	
	Select the volume you want (10 levels).

5.1.3 Configure the ringtone

The phone is in idle state.	
<i>Menu</i>	Press the Menu soft key to access the Main Menu.
<i>Basic Setting</i>	Use up-down and 'ok' navigation keys to select: <i>Basic Setting</i> .
<i>Sound</i>	Use up-down and 'ok' navigation keys to select: <i>Sound</i> .
<i>Ringing</i>	Use up-down and 'ok' navigation keys to select: <i>Ringing</i> .
<i>Ring mode</i>	Use up-down and 'ok' navigation keys to select: <i>Ring mode</i> .
<i>Switch</i> or 	<ul style="list-style-type: none"> <i>Normal ringing</i> A normal ring signals an incoming call. <i>Progressive ringing</i> A progressive ring signals an incoming call.
<i>Switch</i> or 	Enable or disable the silent mode: <i>Silent mode</i> . The phone no longer rings. The LED flashes to signal an incoming call.
 or <i>Save</i>	Validate your choice.
	To end the settings.



5.1.4 Configuring discreet mode (beep)

The phone is in idle state.	
<i>Menu</i>	Press the Menu soft key to access the Main Menu.
<i>Basic Setting</i>	Use up-down and 'ok' navigation keys to select: <i>Basic Setting</i> .
<i>Sound</i>	Use up-down and 'ok' navigation keys to select: <i>Sound</i> .
<i>Ringling</i>	Use up-down and 'ok' navigation keys to select: <i>Ringling</i> .
<i>Beep</i>	Use up-down and 'ok' navigation keys to select: <i>Beep</i> .
<i>Switch</i> or 	<ul style="list-style-type: none"> <i>0 Beep</i> A normal ring signals an incoming call. <i>1 Beep</i> A beep followed by the ring signals an incoming call. <i>3 Beep</i> Three beeps followed by the ring signals an incoming call.
 or <i>Save</i>	Validate your choice.
	To end the settings.

5.1.5 Seat mode



Your desk phone supports the seat mode. The seat mode lets your administrator switch the ringing onto the loudspeaker, the headset or both. This feature is configurable from the Web Management. Contact your administrator for more information.

5.2 Selecting language



The phone is in idle state.	
<i>Menu</i>	Press the Menu soft key to access the Main Menu.
<i>Basic Setting</i>	Use up-down and 'ok' navigation keys to select: <i>Basic Setting</i> .
<i>Language</i>	Use up-down and 'ok' navigation keys to select: <i>Language</i> .
	Select the language of your choice.
 or <i>Save</i>	Validate your choice.
	To end the settings.

5.3 Adjusting the brightness of the desk phone



The phone is in idle state.	
<i>Menu</i>	Press the Menu soft key to access the Main Menu.
<i>Basic Setting</i>	Use up-down and 'ok' navigation keys to select: <i>Basic Setting</i> .
<i>Display</i>	Use up-down and 'ok' navigation keys to select: <i>Display</i> .
<i>Backlight</i>	Use up-down and 'ok' navigation keys to select: <i>Backlight</i> .
Use right-left navigation keys to adjust the brightness.	
<i>Active Level</i>	Adjust the brightness when the phone is in use.

<i>Inactive Level</i>	Adjust the dimmed brightness when the phone is not in use.
<i>Backlight Time:</i>	Set the time-out duration for the phone backlight.
	Select the language of your choice.
 or <i>Save</i>	Validate your choice.
	To end the settings.

5.4 Enable screensaver and define the delay

The phone is in idle state.	
<i>Menu</i>	Press the Menu soft key to access the Main Menu.
<i>Basic Setting</i>	Use up-down and 'ok' navigation keys to select: <i>Basic Setting</i> .
<i>Display</i>	Use up-down and 'ok' navigation keys to select: <i>Display</i> .
<i>Screen saver</i>	Use up-down and 'ok' navigation keys to select: <i>Screen saver</i> .
Use right-left navigation keys to adjust the brightness.	
<i>Screen saver</i>	Enable screensaver and define the delay (use right-left navigation keys).
<i>Wait Time</i>	Enter the idle time in seconds before the screensaver starts.
 or <i>Save</i>	Validate your choice.
	To end the settings.



5.5 Define the voicemail number

The phone is in idle state.	
<i>Menu</i>	Press the Menu soft key to access the Main Menu.
<i>Voicemail</i>	Use up-down and 'ok' navigation keys to select: <i>Voicemail</i> .
<i>Set Voicemail Number</i>	Use up-down and 'ok' navigation keys to select: <i>Set Voicemail Number</i> .
	Enter the voicemail number of the corresponding account.
 or <i>Save</i>	Validate your choice.
	To end the settings.



5.6 Programmable keys

Depending on the phone, you can program between 15 and 27 keys. You can connect an add-on module to have more programmed keys (sold separately).

5.6.1 Create a programmable key

	Long press on a programmable key.
<i>Switch</i> or 	Define the type of programmable key. Depending on the type of key, fill in the options.
 or <i>Save</i>	Save the programmed key.

5.6.2 Delete a key

	Long press on a programmed key.
<i>Switch</i> or 	<i>Undefined</i>
 or <i>Save</i>	Save.

5.6.3 Type of programmed key

- *Undefined*: delete a programmed key.
- *Account*: line Key.
 - *Account*: select the relevant SIP account.
 - *Label*: enter the label of the key, displayed on the home page.
- *Speed Dial*: speed dial key (direct call key).
 - *Account*: select the relevant SIP account.
 - *Label*: enter the label of the key, displayed on the home page.
- *BLF* (Busy Lamp Field): indicates whether another extension connected to the same system is busy or not. Use the BLF key to make a direct call or pick up a call from the defined number.
 - *Account*: select the relevant SIP account.
 - *Label*: enter the label of the key, displayed on the home page.
 - *Value*: the number of the extension which the user wishes to monitor.
 - *Extension*: a list of extensions which the user wishes to monitor.
- *BLF List*: a list of extensions which the user wishes to monitor. The list is defined by your administrator via the WBM or a configuration file.
 - *Label*: enter the label of the key, displayed on the home page.
- *Hold*: place or retrieve the call on hold.
 - *Label*: enter the label of the key, displayed on the home page.
- *Transfer*: transfer function.
 - *Label*: enter the label of the key, displayed on the home page.
- *Conference*: conference call function.
 - *Label*: enter the label of the key, displayed on the home page.
- *ReCall*: redial the last incoming number.
 - *Label*: enter the label of the key, displayed on the home page.
- *DND*: do not disturb function.
 - *Label*: enter the label of the key, displayed on the home page.

- **Directory**: open the local directory.
 - **Label**: enter the label of the key, displayed on the home page.
- **Forward**: immediate forward to a number.
 - **Label**: enter the label of the key, displayed on the home page.
 - **Value**: dial the destination number.
- **Voicemail**: consulting your voice mailbox.
 - **Account**: select the relevant SIP account.
 - **Label**: enter the label of the key, displayed on the home page.
 - **Value**: enter the voicemail prefix code.
- **Hot Desking**: desk sharing function.
 - **Label**: enter the label of the key, displayed on the home page.
- **Prefix**: open the dialpad with predefined prefix.
 - **Account**: select the relevant SIP account.
 - **Label**: enter the label of the key, displayed on the home page.
 - **Value**: Prefix.
- **DTMF**: sending a predefined DTMF signal during conversation.
 - **Label**: enter the label of the key, displayed on the home page.
 - **Value**: DTMF code.
- **DirectPickup**: call pick-up.
 - **Account**: select the relevant SIP account.
 - **Label**: enter the label of the key, displayed on the home page.
 - **Value**: enter the pickup code followed by the extension number.
- **GrpPickup**: group call pick up.
 - **Account**: select the relevant SIP account.
 - **Label**: enter the label of the key, displayed on the home page.
 - **Value**: enter the group pickup code followed by the group number.
- **Headset**: activate/Deactivate Headset mode.
 - **Label**: enter the label of the key, displayed on the home page.
- **GroupListen**: activate/deactivate group listen audio mode.
 - **Label**: enter the label of the key, displayed on the home page.
- **Intercom**: make a call to a contact who will answer the call automatically.
 - **Account**: select the relevant SIP account.
 - **Label**: enter the label of the key, displayed on the home page.
 - **Value**: enter the contact number to call.
- **Audio Hub**: use your desk phone as a USB audiohub for your computer.
 - **Label**: enter the label of the key, displayed on the home page.
- **XML Browser**: display an XML page.
 - **Label**: enter the label of the key, displayed on the home page.
 - **Value**: enter the URL of the XML page.
- **Phone Lock**: lock/unlock the phone.
 - **Label**: enter the label of the key, displayed on the home page.

These keys can be also configured by the administrator via Web Management or via the configuration file.

Led behavior may differ depending on the system configuration.

For more information, contact your installer or administrator.

5.7 Call pick-up

You hear a telephone ringing in an office where no-one can answer. If authorised, you can answer the call on your own telephone.

The system can be configured to prevent call pick-up on some telephones.

Before using this feature, you have to program a key on the home page with the following feature:



GrpPickup, DirectPickup.

- If the telephone ringing is in your own pick-up group:
select the programmed key: *GrpPickup*.
- If the telephone ringing is not in your pick-up group:
select the programmed key: *DirectPickup*.

5.8 Install a USB accessory (Headset, Handsfree, Loudspeaker)

- Connect the accessory to the USB connector.
- When you plug the accessory in the USB port, the USB accessory is automatically detected. If an another accessory is already connected with the same function (USB and jack), a pop-up will ask you to select your preferred accessory to use for this function.

If you are using an external hands-free device, configure the audio for this purpose:

The phone is in idle state.	
<i>Menu</i>	Press the Menu soft key to access the Main Menu.
<i>Basic Setting</i>	Use up-down and 'ok' navigation keys to select: <i>Basic Setting</i> .
<i>Sound</i>	Use up-down and 'ok' navigation keys to select: <i>Sound</i> .
<i>External Device</i>	Use up-down and 'ok' navigation keys to select: <i>External Device</i> .
<i>Switch</i> or 	Enable external hands-free.
 or <i>Save</i>	Validate your choice.



If you want the headset to ring only when receiving an incoming call, you must activate the headset mode.

5.9 Headset mode





You can use a headset with your phone. If you want the headset to ring only when receiving an incoming call, you must activate the headset mode.

Before using this feature, you have to program a key on the home page with the following feature:

Headset.

The phone is in idle state.	
Connect the headset to the desk phone.	
	Select the programmed key: <i>Headset</i> .
	This icon is displayed on your desk phone:  .

5.10 Define time and date format

The phone is in idle state.	
<i>Menu</i>	Press the Menu soft key to access the Main Menu.
<i>Basic Setting</i>	Use up-down and 'ok' navigation keys to select: <i>Basic Setting</i> .
<i>Time and Date</i>	Use up-down and 'ok' navigation keys to select: <i>Time and Date</i> .
<i>Switch</i> or 	<i>Date</i> : choose the date format.
<i>Switch</i> or 	<i>Time</i> : select Time Format.
 or <i>Save</i>	Validate your choice.
	To end the settings.

5.11 Manage Bluetooth® device (M7)

This feature is only available with compatible Bluetooth® desk phone. Otherwise the corresponding menu is not displayed or is inactive. You can pair one Bluetooth® device, such as headphones, with your desk phone.



5.11.1 Installing a Bluetooth® device

Before performing the pairing operation, the device must be in detectable mode. Consult the user documentation of your Bluetooth® device.



The phone is in idle state.	
<i>Menu</i>	Press the Menu soft key to access the Main Menu.
<i>Basic Setting</i>	Use up-down and 'ok' navigation keys to select: <i>Basic Setting</i> .
<i>Bluetooth</i>	Use up-down and 'ok' navigation keys to select: <i>Bluetooth</i> .
<i>Scan</i>	Press the softkey under the following label: <i>Scan</i> . Scanning starts. Searching for Bluetooth® equipment. Wait for the detected equipment type and address to be displayed.
<i>Connect</i>	Add the device by pressing on the associated key: <i>Connect</i> .
	Enter the PIN code of the device if necessary.

This icon is displayed on your desk phone:  .

If you are using an external hands-free device, configure the audio for this purpose:

The phone is in idle state.	
<i>Menu</i>	Press the Menu soft key to access the Main Menu.
<i>Basic Setting</i>	Use up-down and 'ok' navigation keys to select: <i>Basic Setting</i> .
<i>Sound</i>	Use up-down and 'ok' navigation keys to select: <i>Sound</i> .
<i>External Device</i>	Use up-down and 'ok' navigation keys to select: <i>External Device</i> .
<i>Switch</i> or 	Enable external hands-free.
 or <i>Save</i>	Validate your choice.

5.11.2 List connected devices

The phone is in idle state.	
<i>Menu</i>	Press the Menu soft key to access the Main Menu.
<i>Basic Setting</i>	Use up-down and 'ok' navigation keys to select: <i>Basic Setting</i> .
<i>Bluetooth</i>	Use up-down and 'ok' navigation keys to select: <i>Bluetooth</i> .
<i>Paired Bluetooth Device</i>	Use up-down and 'ok' navigation keys to select: <i>Paired Bluetooth Device</i> . The paired devices are listed.
	Select a device.
 or <i>More</i> → <i>Detail</i>	Display information about the selected device (name, MAC address).

5.11.3 Removing a Bluetooth® accessory (headset, handset, etc.)

The phone is in idle state.	
<i>Menu</i>	Press the Menu soft key to access the Main Menu.
<i>Basic Setting</i>	Use up-down and 'ok' navigation keys to select: <i>Basic Setting</i> .
<i>Bluetooth</i>	Use up-down and 'ok' navigation keys to select: <i>Bluetooth</i> .
<i>Paired Bluetooth Device</i>	Use up-down and 'ok' navigation keys to select: <i>Paired Bluetooth Device</i> . The paired devices are listed.
	Select a device.
<i>Delete</i>	Remove the selected device.

5.11.4 Removing all Bluetooth® accessories

The phone is in idle state.	
<i>Menu</i>	Press the Menu soft key to access the Main Menu.
<i>Basic Setting</i>	Use up-down and 'ok' navigation keys to select: <i>Directory</i> .
<i>Bluetooth</i>	Use up-down and 'ok' navigation keys to select: <i>Bluetooth</i> .
<i>Paired Bluetooth Device</i>	Use up-down and 'ok' navigation keys to select: <i>Paired Bluetooth Device</i> . The paired device is listed.
<i>More</i> → <i>Delete all</i>	Remove all devices. Note that no confirmation is requested.

5.11.5 Edit the name of your desk phone

The phone is in idle state.

<i>Menu</i>	Press the Menu soft key to access the Main Menu.
<i>Basic Setting</i>	Use up-down and 'ok' navigation keys to select: <i>Basic Setting</i> .
<i>Bluetooth</i>	Use up-down and 'ok' navigation keys to select: <i>Bluetooth</i> .
<i>Edit My Device Info</i>	Use up-down and 'ok' navigation keys to select: <i>Edit My Device Info</i> . The name and the MAC address of your desk phone is displayed. You can change the name.
 or <i>Save</i>	Validate your choice.

6 Contacting your administrator (technical support)

If necessary you may need to contact your administrator.

Before contacting your administrator, make sure you have information such as your phone's codes and software version to hand.

6.1 Technical code / Date code

The codes are located under the backshell of the phone. This label is an example and does not represent the one placed on your phone.

- 1 Technical code.
- 2 Date code.



6.2 Software version / Display network settings (IP address)

The software version can be viewed on the phone by following this path:

The phone is in idle state.

Use one of the following:



Menu → *Status*

6.3 Access to administrator configuration

6.3.1 Administrator settings menu

The phone is in idle state.	
<i>Menu</i>	Press the Menu soft key to access the Main Menu.
<i>Advanced Setting</i>	Use up-down and 'ok' navigation keys to select: <i>Advanced Setting</i> .
<i><Abc><123></i>	Enter the administrator password.
	This section allows the administrator to set IP parameters, certificates, LDAP servers, DM URL (for configuration files), and SIP Accounts. The administrator can also restore factory settings. The DM URL is used to automatically download the phone's configuration file, including all parameters, when the phone switches on.

6.3.2 Web Management (WM)

Web Management offers the administrator an easy way to configure the settings of your phone through a web page hosted by your phone.

When the phone is connected to the network, your administrator can access the Web Management via a web browser by entering the IP address of your phone. The administrator password of the phone is requested. When connecting for the first time, the default password has to be modified.

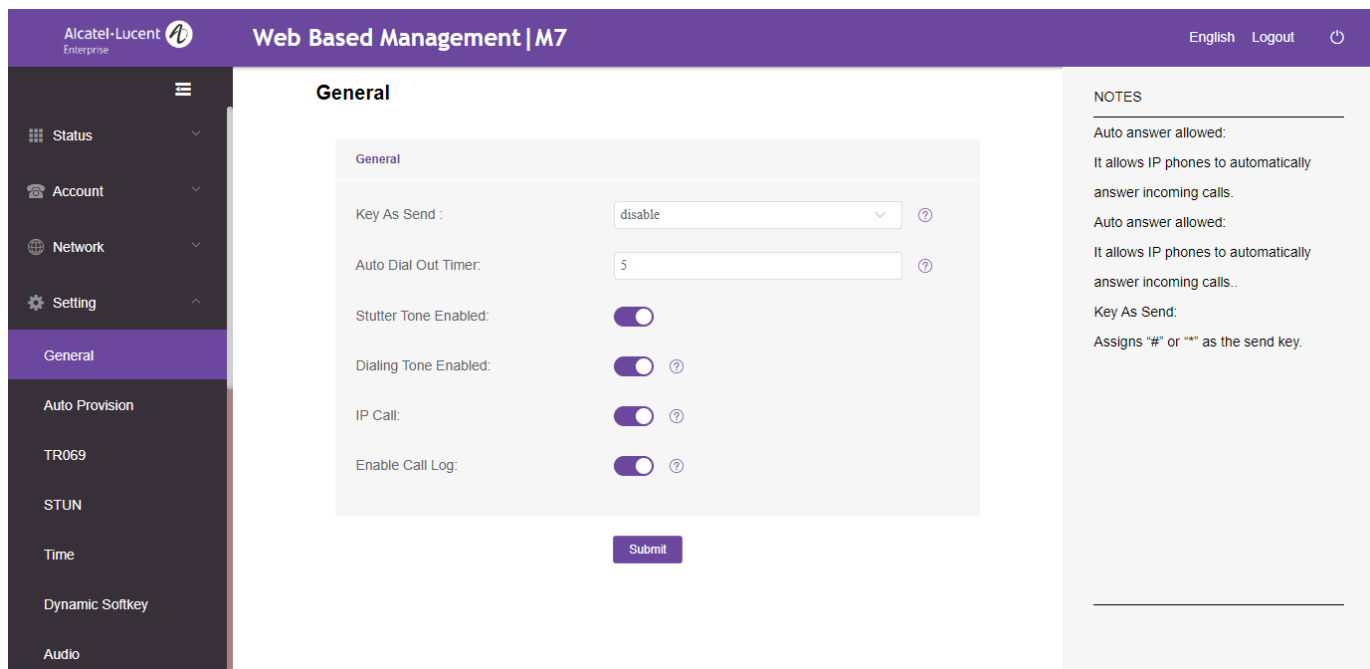

From the Web Management, your administrator can configure all SIP accounts of the desk phone.

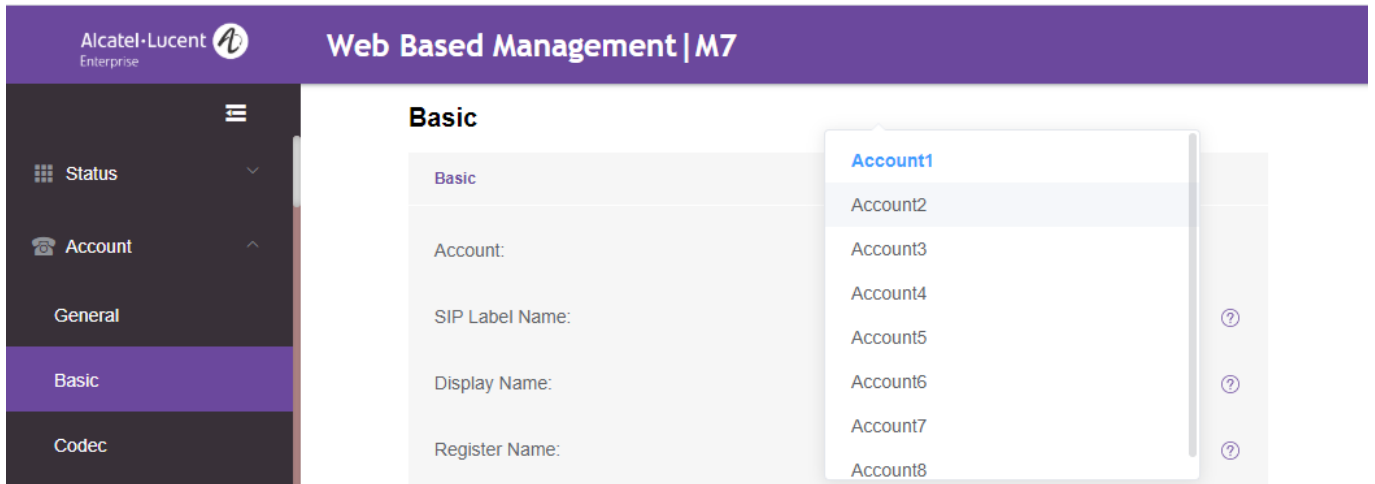

The administrator can define the 3 dynamic keys displayed on the homepage.

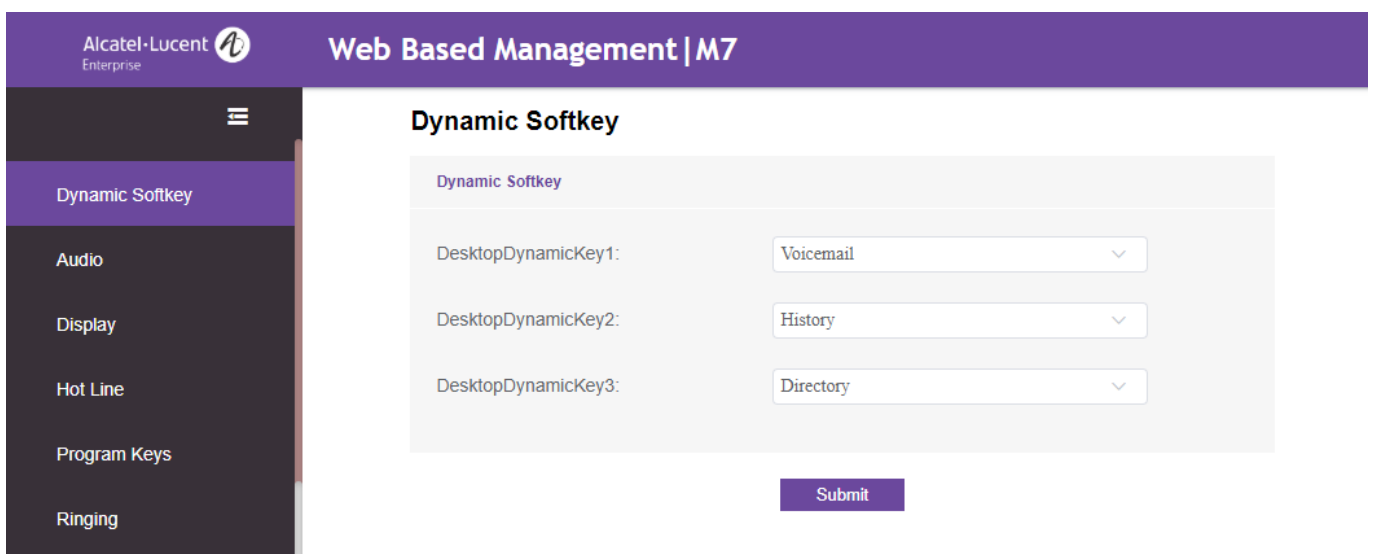

All configuration parameters of the desk phone can be managed from the Web Management.

- Audio (Ringing, Tone, hearing aids...).
- Backlight, Screensaver, automatic lock.
- Date format, time format.
- Forward, Do not disturb.
- Hotline number.
- Intercom.
- Programmed keys displayed on the desk phone.
- USB mode (host, slave).
- Network configuration (DM, DNS, Ethernet, IP parameters, LDAP).
- VPN configuration.

7 Accessories

The ALE-supported accessories are intended to work smoothly on most/all of our clients (hardphones, softphones). The list of accessories presented in this document is not contractually binding and may be modified without prior warning.

7.1 List of accessories

7.1.1 USB headset

You can use a USB headset to handle calls on the DeskPhone M3 / M5 / M7. To know the supported headsets, please refer to the Alcatel-Lucent Enterprise website or contact your administrator. Unlisted USB headsets may not work properly if you connect them to your phone. For more information on using your USB headset, refer to the corresponding documentation from the manufacturer.

7.1.2 Add-on module

- M20 Expansion Module.
- EM200 Smart Expansion Module.

7.1.3 Conference module

- Konftel EGO.
- 8135s IP Conference Phone.

7.1.4 Adapter

- USB C to USB-A CABLE (box of 10).

7.1.5 USB Dongle

To know the supported dongle, please refer to the Alcatel-Lucent Enterprise website or contact your administrator.

7.1.6 Other accessories (headsets)

Please consult the following sites of providers for compatible headsets:

- <https://www.plantronics.com/us/en/solutions/alcatel-lucent>
- <https://en-de.sennheiser.com/alcatel-lucent-headsets-unified-communications>
- <https://www.emea.jabra.com/business/for-your-platform/alcatel-lucent>

7.2 Add-on module



Phone capabilities can be extended with Add-ons:

- The EM200 add-on offers 60 additional keys with LED, color screen.
- The EM20 add-on offers 20 additional keys with LED and paper label.

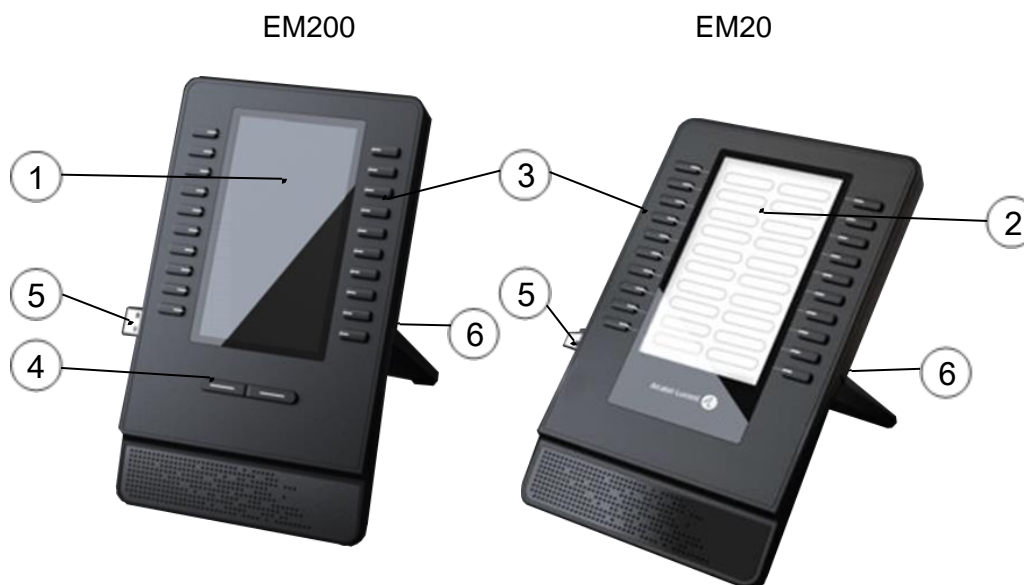

1	LCD screen.	4	Page navigation keys.
2	Paper label.	5	Connector to connect the device to the desk phone or already connected add-on (USB-A).
3	Programmable keys.	6	Universal Serial Bus (USB-a) connector. This connector is used for: <ul style="list-style-type: none"> • Connect a USB headset. • Connect an add-on module. • Connect a Wi-Fi dongle*.

*To know the supported dongle, please refer to the Alcatel-Lucent Enterprise website or contact your administrator.

7.2.1 install the add-on to the desk phone

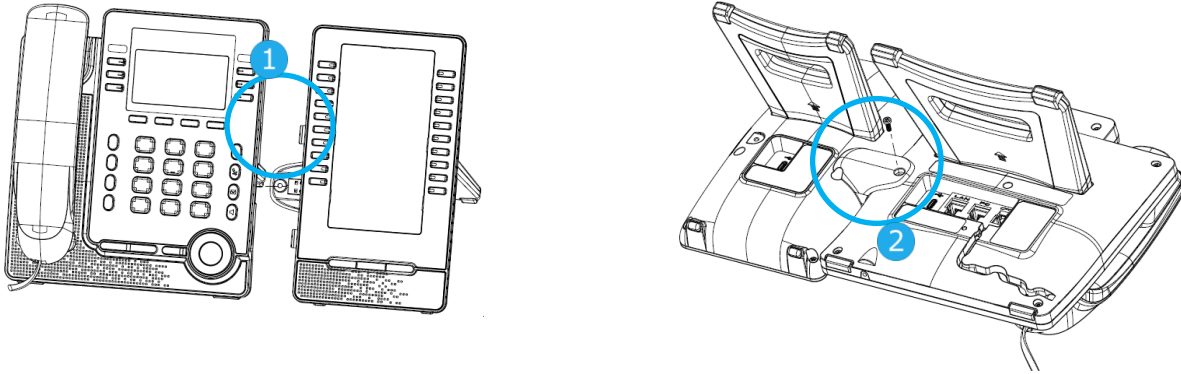

- 1- Insert the add-on USB-A connector into the USB-A socket of the desk phone.
- 2- Use the add-on support to fix it to the desk phone using the provided screw.
- 3- The add-on is powered by the desk phone if the desk phone is connected to an external power adapter.

If your desk phone is powered via PoE, we recommend connecting the EM200 to an USB-C power adapter (DC 5V/2A output, not provided with the add-on).

- 4- Restart the desk phone (unplug and plug in the power jack if you are using an external power adapter or the Ethernet connector – LAN).

7.2.2 Install more than one add-on module

It is possible to connect up to three similar add-on modules. It is not possible to connect EM20 and EM200 add-ons together.

Depending on how the desk phone is powered, you need to use an external power adapter (DC 5V/2A output, not provided with the add-on) connected to the add-on.

Your desk phone is powered via PoE:

- You can connect up to two EM20 without an external power adapter.
- You can connect three EM20s. One of the add-ons must be connected to an external power adapter.
- You can connect up to two EM200s. One of the add-ons must be connected to an external power adapter.

Your deskphone is powered via an external power adapter:

- You can connect up to three EM20s without an external power adapter.
- You can connect up to two EM200s without an external power adapter.
- You can connect three EM200s. One of the add-ons must be connected to an external power adapter.

To attach another add-on, affix and connect the new add-on to the one that is already connected:

- The first add-on is connected to the desk phone.
- Insert the new add-on USB-A connector into the USB socket of the installed add-on.
- Use the add-on support to fix it to the add-on using the screw provided.
- Restart the desk phone (unplug and plug in the power jack if you are using an external power adapter or the Ethernet connector – LAN).

7.2.3 Changing or updating the paper label

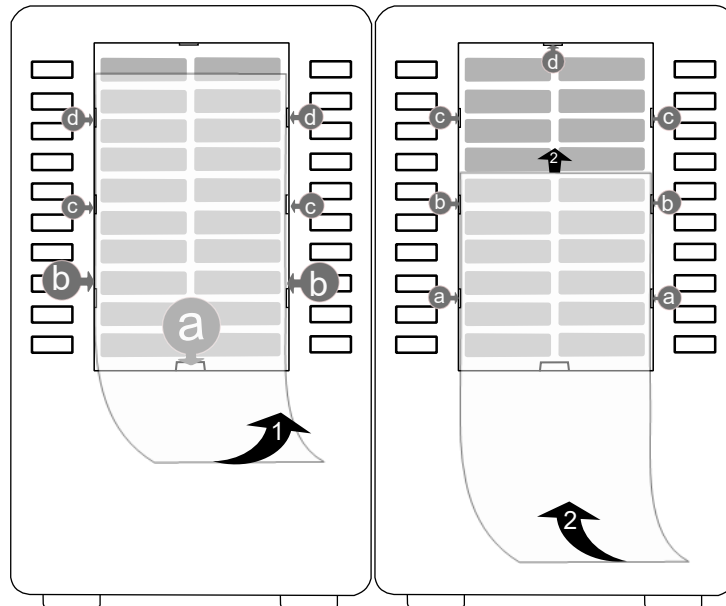

- Remove the protective cover (1): insert a thin object (or your fingernail) in the slot (a) to lift the protective cover. Slide the cover down. The cover is held in place by small notches, take care not to break the plastic cover near the notches. Remove the cover from the other notches (c, d) by moving the cover gently from right to left.
- Remove the paper label with a thin object.
- Replace the paper label and protective cover (2): the cover or the paper can only be placed in the right way. Insert the paper label under the first notches (a). Then, insert the other notches by sliding the paper up (b, c, d). If necessary, you can gently press the paper near the notch to help it to slide under the notch.
- Put the protective cover back in the same way.

Paper label and paper label cover can be ordered separately.

7.3 Konftel EGO

The Konftel EGO is a compact and portable conference module. It provides OmniSound® audio technology for very high-quality HD audio conversations. In addition, the Konftel EGO comes with a 1000m Ah Li-ion battery for up to 12 hours of meetings and calls. The Konftel EGO can be connected to your desk phone, mobile phone, tablet and computer. This section describes how to use the conference module with your desk phone. To use the Konftel EGO with your computer, mobile phone, or tablet, or for more information about the device, see the complete user manual of the device (8AL90358xxAA).

7.3.1 Box content

- Konftel EGO

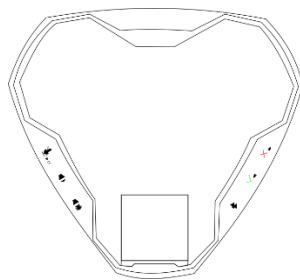

- Konftel EGO case



- Micro-USB cable



7.3.2 Description

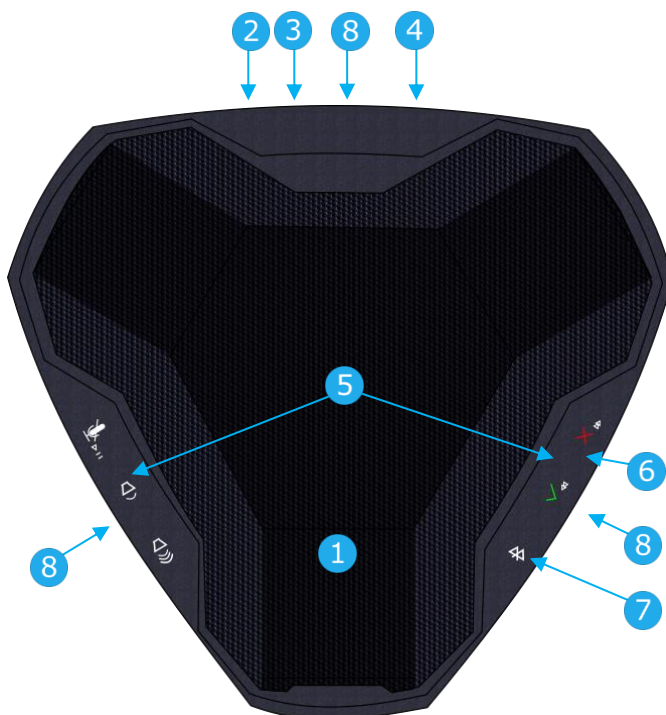

1 Color display.

2 Off/on button.

- Push the button to start.







2

- Hold down the button for five seconds to manually switch off.
- The Konftel EGO switches off automatically after 30 minutes.

3 USB connector (micro type B).

4 3.5 mm, 4 pole jack (TRRS standards: CTIA)

Audio control buttons

-  Activating and disactivating the mute.
-  Turn up the volume.
-  Turn down the volume.
-  Start/pause music.
-  Previous music.
-  Next music.

Call control buttons

- 6**
-  End the call.
 -  Answer the call.

7  Button for pairing Bluetooth®.













8 IED (IEDs on all sides).

7.3.3 LED description

- Steady yellow: the device is switched on.
- Blue steady: connected through Bluetooth®.
- Green steady: microphone is enabled/call in progress (Bluetooth®).
- Flashing green: incoming call (Bluetooth®).
- Flashing blue: pairing or connecting in progress (Bluetooth®).
- Red steady: microphone switched off during calls (mute).
- Flashing red: Low battery.
- Flashing slowly: the call is placed on hold (Bluetooth®).

7.3.4 Icons displayed on the screen

The icons are normally displayed for a couple of seconds on connection. The same symbol is displayed in red when the connection is broken.

	USB device connected.		Incoming call or call in progress via Bluetooth®.
	Incoming call or call in progress via USB.		Music mode via Bluetooth®.
	Music mode via USB.		Headset connected.
	Visible for pairing via Bluetooth®.		Volume adjustment (number of bars indicates the volume selected).
	Reconnecting to Bluetooth® device.		Microphone switched off (mute).
	Bluetooth® device connected.		Battery status.

7.3.5 Battery charge



Displayed automatically when there is 1 hour remaining and then every 5 minutes. The number of bars in the battery icon indicates the charging status. The battery needs charging when the icon turns red. Charging the battery with a USB cable.

7.3.6 Turning off and on

The Konftel EGO starts automatically when it is connected with the provided USB cable to the desk phone or powered-up computer.





- Push the button to start the device manually.
- Hold down the button for five seconds to manually switch off.



7.3.7 Connect the device to the desk phone using the USB cable

- Connect the device to the USB type A connector of the desk phone using the provided USB cable. The Konftel EGO automatically starts. The following icon is displayed on the screen of the device: .
- The Konftel EGO is detected as a hands-free device. Select 'Konftel Ego' on the pop-up displayed on your desk phone.
- The device is ready for use.

7.3.8 Connect the device to the desk phone using Bluetooth® (compatible Bluetooth® desk phone)

-  Switch on the Konftel EGO.
- Put the device in detectable mode: hold the Bluetooth® button down for two seconds on the Konftel EGO: . The following icon is displayed on the screen of the device: .
- From your desk phone, pairing the Konftel EGO:

	The phone is in idle state.
<i>Menu</i>	Press the Menu soft key to access the Main Menu.
<i>Basic Setting</i>	Use up-down and 'ok' navigation keys to select: <i>Basic Setting</i> .
<i>Bluetooth</i>	Use up-down and 'ok' navigation keys to select: <i>Bluetooth</i> .
<i>Paired Bluetooth Device</i>	Use up-down and 'ok' navigation keys to select: <i>Paired Bluetooth Device</i> .
<i>Scan</i>	Press the softkey under the following label: <i>Scan</i> . Scanning starts. Select the relevant equipment: "Konftel Ego"
<i>Connect</i>	Add the device by pressing on the associated key: <i>Connect</i> .







- The Konftel EGO is successfully paired. The following icon is displayed a couple of seconds on the Konftel EGO screen: . It is detected as a Bluetooth® headset. The following icons are displayed on the status bar of your desk phone: , .

P86_9182: .

To remove the device, follow instructions described in the section: "Removing a Bluetooth® accessory (headset, handset, etc.)".

7.3.9 Using the Konftel EGO

The Konftel EGO is used as an external hands-free device.

- When you receive a call, the device is ringing and an icon is displayed on the screen:  / . The leds are flashing green.
-  Answer the call.
-  Activate/deactivate the mute feature during a conversation. The mute icon is displayed on the Konftel EGO if activated: .
- Use the volume buttons of the desk phone or Konftel EGO to turn the volume up or down.
-  End the call. You can end the call from the desk phone.

You can resume the call with the handset at any time by unhooking it or by switching between audio mode ()

7.4 Wall mounting kit

To mount your phone on the wall, you need to install a standard wall plate that you can easily find on the market. Follow the manufacturer's instructions to install the wall plate on the wall. When the wall plate is fixed, you can prepare your phone and mount it on the wall. The wall mount kit is sold separately (refer to the following chapter for the reference: Ordering information).

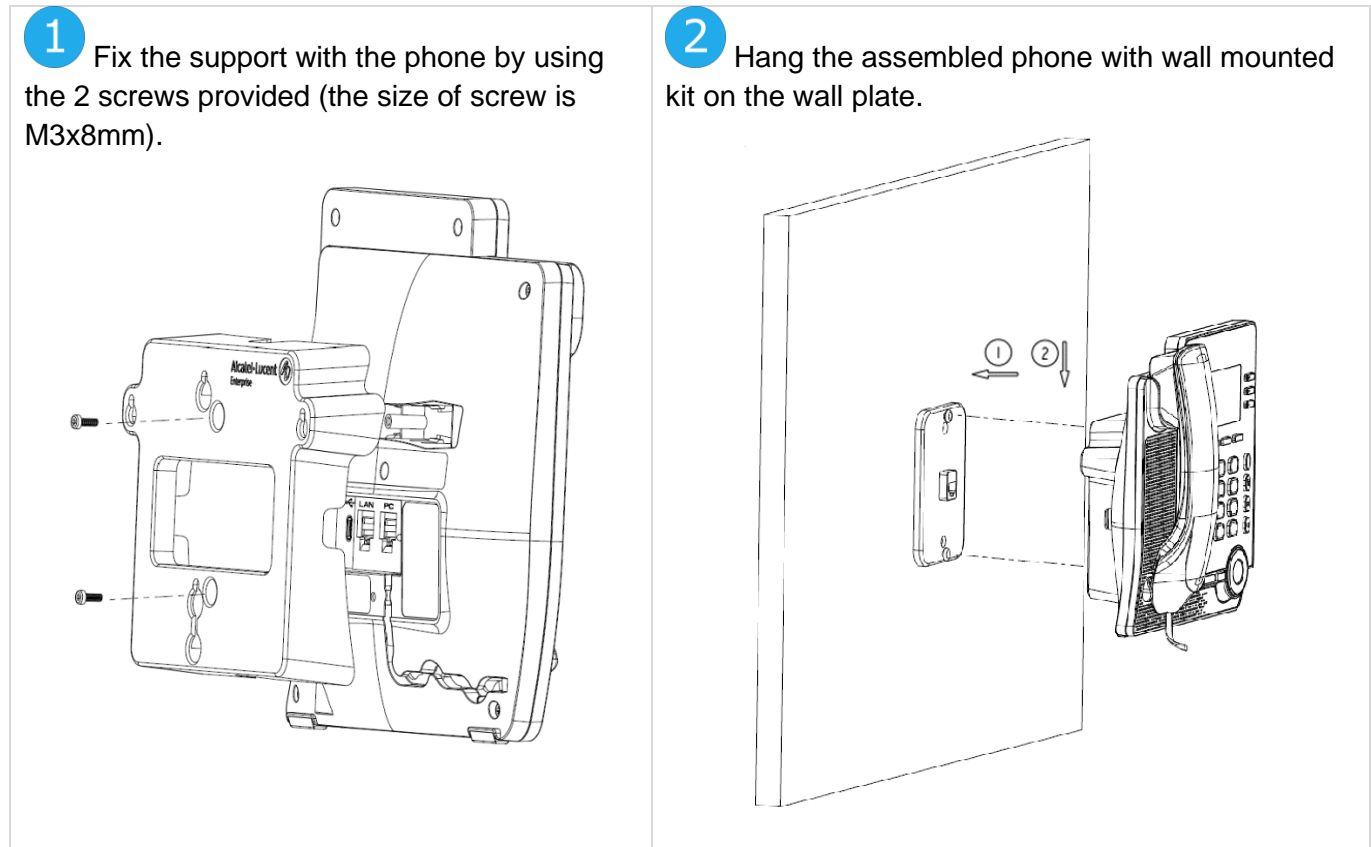

7.5 Developer and Solution Partner Program (DSPP)

The mission of the DSPP is to support a broad ecosystem of developers and partners throughout the desk phone lifecycle. In this context, certification tests are performed between partner applications or devices and Alcatel-Lucent Enterprise's platforms. It certifies proper inter-working with partner applications or devices. Results of certification tests for headsets can be consulted by following the links below.

- IWR-0121: Sennheiser Headsets / Desk phones
<https://www.al-enterprise.com/-/media/assets/internet/documents/sennheiser-headsets-terminals-iwr-0121-ed10-en.pdf>
- IWR-0018: Jabra Headsets for hardphones
<https://www.al-enterprise.com/-/media/assets/internet/documents/iwr-0018-ed03-gn-jabra-headsets-amplifiers-omnipcxplatformsterminals.pdf>
- IWR-0164: Plantronics-Headsets-Amplifiers
<https://www.al-enterprise.com/-/media/assets/internet/documents/plantronics-headsets-amplifiers-iwr-0164-ed04.pdf>

8 Technical specifications

	M7	M5	M3
Width	207 mm (8, 2 in)	207 mm (8, 2 in)	207 mm (8,15 in)
Height	183 mm (7,2 in)	183 mm (7,2 in)	183 mm (7,2 in)
Weight	810 g (1,79 lbs)	800 g (1,77 lbs)	806 g (1,78 lbs)
2-degree adjustable foot	40° - 55°	40° - 55°	40° - 55°
Color	Gray	Gray	Gray
Display	3.5 inch color, 320 x 240 pixels	2.8 inch color, 320 x 240 pixels	2.8 inch monochrome with backlight, 128 x 64 pixels
Memory (Flash/SDRAM)	256 MB/256MB	256 MB/256MB	256 MB/128MB
Power over Ethernet (IEEE 802.3af)	Class 2	Class 2	Class 2
Power consumption (PoE) Idle – Active(w/o Add-on, w/o USB)	< 3.5 W	< 3.5 W	< 3.5 W
Operating conditions	-5°C - +45°C (23°F - 113°F)	-5°C - +45°C (23°F - 113°F)	-5°C - +45°C (23°F - 113°F)

	Konftel EGO
Maximum distance between the phone set and the device	
Width	145 mm (5,7in)
Depth on a table	135 mm (5,31in)
Height	32 mm (1,26in)
Weight	230 g (0,51 lb.)
Adjustable foot stand range	
Color	Licorice black
Power consumption	Battery: 1000 mAh Li-ion aC adapter: power and charging via USB.
UL/CSA Ratings	
Operating conditions	5° C à 40° C (41 °F - 104 °F)

9 Ordering information

M7 DeskPhone	3MK27003AA
M5 DeskPhone	3MK27002AA
M3 DeskPhone	3MK27001AA
EM20 Expansion Module (add-on module)	3MK27006AA
EM200 Smart Expansion Module (add-on module)	3MK27007AA
USB C to USB-A cable (box of 10)	3MG08020AA
Wide Band Comfort Handset	3MG27032AA
USB Binaural Headset	3GV28057AB
Wall mounting kit	3MK27008AA
USB-C Power Adapter (100–240 V AC/5 V DC) (US)	3MK08005US
USB-C Power Adapter (100–240 V AC/5 V DC) (EU)	3MK08005EU
USB-C Power Adapter (100–240 V AC/5 V DC) (RW)	3MK08005RW
Konftel EGO	3MG08017AA
8135s IP Conference Phone	3MG07040AA

10 Guarantee and clauses

Current Safety and Regulatory Statements relate to the following products (do not apply to accessories): M3 DeskPhone, M5 DeskPhone, M7 DeskPhone.

10.1 Safety Instructions

- Changes or modifications to the equipment not expressly approved by the party responsible for compliance could void the user's authority to operate the equipment.
- Magnets could affect the functioning of pacemakers and implanted heart defibrillators. Keep a safe distance between your pacemaker or implant defibrillator and the handset which includes magnetic elements: 4 centimeters (1,6 inches) at least.
- To limit the risk of interference, people with pacemakers must keep the wireless telephone away from their equipment (minimum distance of 15 cm/6 inches).
- It is recommended to follow the standard acceptance procedures before using this equipment in human safety critical areas (hospitals...).
- The handset includes magnetic elements that may attract sharp metallic objects. To prevent injury, before each use ensure sharp metallic objects are not stuck to the earpiece and microphone.
- Avoid using phones (other than cordless type) during an electrical storm. There may be a remote risk of electric shock from lightning.
- Do not use this device in environments where there is a danger of explosion.
- Do not plug this phone into an Integrated Services Digital Network (ISDN) connection or into a regular Public Switched Telephone Network (PSTN) connection. This can result in severe damage to the phone.
- Never allow your telephone to come into contact with water.
- To clean your telephone, use a soft damp cloth. Never use solvents (trichlorethylene, acetone, etc.) which may damage the plastic parts of your telephone. Do not use aerosol cleaners.
- M3/M5/M7 DeskPhone: this product is intended to be supplied, either via the Ethernet (LAN) port (Minimum Class 2 according to IEEE802.3af), or via the DC-in by a Certified Direct Plug-In Power Unit approved as 'LPS' (Limited Power Source) against IEC/EN/UL/CSA 62368-1 and rated 5V dc, minimum 2A. Allowed power supply is: WB-10N05 – Asian Power Devices Inc.
- EM200/EM20 Expansion Module: this product is intended to be powered either via the USB-A port from the M3/M5/M7 DeskPhone, or via the USB-C DC-IN by a Certified Direct Plug-In Power Unit approved as an 'LPS' (Limited Power Source) in accordance with IEC/EN/UL/CSA 62368-1 and rated 5V DC, minimum 2A. Other power supply products from the same family are permitted: WB-10N05 – Asian Power Devices Inc.
- If you are connected to a POE connection do not use an external Power Supply.
- The PoE (Power over Ethernet) devices that supply or receive power and their connected cables must all be completely indoors.
- The M7 DeskPhone offers a Bluetooth® radio interface for Bluetooth® devices with a frequency range of 2402-2480 MHz, radiated power 5 mW.

10.2 Regulatory Statements

EUROPE

This equipment complies with the essential requirements of following directives: 2014/53/EU (RED), 2014/30/EU (EMC), 2014/35/EU (LVD), 2009/125/EC (ErP), 2011/65/EU (RoHS), 2015/863 (EU).

Declaration of Conformity may be obtained from: ALE International 32 avenue Kléber – 92700 Colombes, France - ebg_global_supportcenter@al-enterprise.com

USA and Canada

Phones with Bluetooth® comply with Industry Canada's license-exempt RSSs. Operation is subject to the following two conditions: (1) this device may not cause harmful interference, and (2) this device must accept any interference received, including interference that may cause undesired operation.

Phone has been tested without Bluetooth® and was found to comply with the limits for a class B digital device, pursuant to Part 15 of the FCC Rules. These limits are designed to provide reasonable protection against harmful interference in a residential installation. This equipment generates, uses and can radiate radio frequency energy and, if not installed and used in accordance with the instructions, may cause harmful interference to radio communications. However, there is no guarantee that interference will not occur in a particular installation. If this equipment does cause harmful interference to radio or television reception, which can be determined by turning the equipment off and on, the user is encouraged to try correcting the interference by consulting the dealer.

This product meets the applicable Industry Canada technical specifications and the applicable Innovation, Science and Economic Development Canada technical specifications.

Exposure to Radio Frequency Signals

This equipment complies with radiation exposure limits set by FCC/IC and the Council of European Union for an uncontrolled environment. This equipment has very low levels of RF energy and is deemed to be compliant without testing of the specific absorption rate (SAR).

User Instructions

Use this product in temperatures between -5°C to +45°C (23°F to 113°F).

This product is intended for use in an indoor environment only. This apparatus is Hearing Aid Compatible (HAC).

Acoustic shock protection

Maximum sound pressure level for handset is compliant with European, US and Australian standards.

Directive 2003/10/EC specifying the risks inherent in noise at work

The ring contributes towards overall daily noise - at its maximum setting, the level is 105 dBA at 60 cm from terminal. To reduce the level, the following is recommended:- reduce the setting (9 levels of 5 dB) - program a progressive ring.

Privacy

Privacy of communications may not be ensured when using any Bluetooth® device.



Disposal

The equipment must be returned to a collection point for electronic equipment waste disposal.

Related Documentation

Other languages for these Safety and Regulatory Instructions and User Documentation are available at the following Web site: <https://www.al-enterprise.com/products>.

www.al-enterprise.com

The Alcatel-Lucent name and logo are trademarks of Nokia used under license by ALE.

To view other trademarks used by affiliated companies of ALE Holding, visit:

www.al-enterprise.com/en/legal/trademarks-copyright. All other trademarks are the property of their respective owners. The information presented is subject to change without notice. Neither ALE Holding nor any of its affiliates assumes any responsibility for inaccuracies contained herein.

© Copyright 2020 ALE International, ALE USA Inc. All rights reserved in all countries.

Main screen

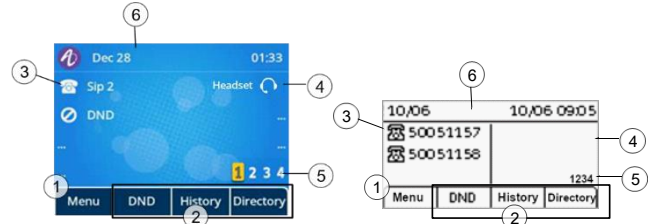

- 1 Menu to access features and configure the phone or manage calls. Press the menu softkeys under the screen to access features. Use the up-down navigation keys to navigate through the menus and to select an entry or an option.
- 2 3 dynamic keys configurable by your administrator to access features of the phone. Line keys associated with SIP account (optional). Press the line key associated with a SIP account to make a call with this account or to answer an incoming call to this account. The 'headset' programmed key allows you to switch to headset mode. Programmed keys. Press the programmed key to use the programmed function or contact. Long press the programmed key to enter into the key configuration. Access to 4 pages. Use the right-left navigation keys or the '1234' programmed key to navigate between pages. The number of the displayed page is highlighted.
- 3 Date, time and status bar.
- 4 **oK key:** use this key to validate your choices and options while programming or configuring (short press). **left-right navigator:** use to move from one page to another or to move the cursor in a text box. **up-down navigator:** use to select an item on a list.
- 5 **Back/Exit key:** use this key to go back to the previous step.
- Bkspc* Use this key to delete one number or character at a time.
- More* Open other functions.

Call management screen

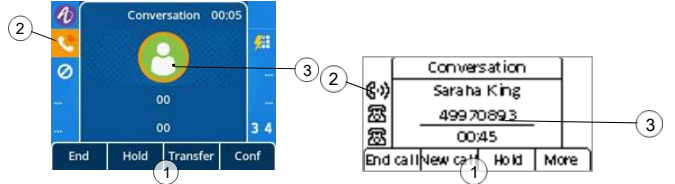

- 1 Softkeys: actions available depending on the call status (when presentation screen is not displayed). Press the softkey under the label to select the corresponding feature.
- 2 SIP account in conversation.
- 3 Incoming call and conversation presentation screen.

Features keys

- Take the call key
Redialing the last number dialed (long press).
List of last numbers dialed (short press).
- Placing a call on hold.
Recover the call on hold.
- Transfer a call.

	Starting a conference call with two contacts.
	Switch off ringer. Hang up. Return to the main page.
	Mute key During a call, press this key to stop your contact from hearing you. When activated, the key is lit red.
	Access the voice mail The message key flashes red when you have received a new voicemail or a missed an incoming call.
	Press this key to open dialer in hands-free mode (idle state). Pressing this key answers an incoming call in hands-free mode (idle state). When a call is in progress, pressing this key switches from hands-free mode to headset or handset mode. When activated, the key is lit blue. Hang up in hands-free mode if the headset mode is not activated.
	Decrease the volume of the ring tone (9 steps) in idle state or when you receive an incoming call. Decrease the volume of the handset, loudspeaker or headset (7 steps) during a conversation.
	Increase the volume of the ring tone (9 steps) in idle state or when you receive an incoming call. Increase the volume of the handset, loudspeaker or headset (7 steps) during a conversation.

Call icons

Icons giving information about some specific configurations of the phone or about call status are displayed in the top bar of the screen. Icons depend on the theme (skin) of the phone.

	SIP account (idle state). A grayed or crossed icon means that the SIP account is not registered (Please contact your administrator). Line keys.
	Incoming call icon.
	Call in progress icon.
	Call on hold icon.

Alpha-numeric keyboard

Your phone is equipped with alphanumeric keyboard.

abc When you are in a text zone, you can switch to the alphabetic keyboard by selecting this key.

123 When alphabetic keyboard is activated, select this key to switch to the numeric keyboard.

Enter alphabetic characters.
The number pad keys have letters that you can display by successive presses. The number is the last character in the series. Some special characters can be displayed by successively pressing the key:

	% \$ / ~ & () [] = *
	@ #
	space - _ 1
	+ . , ; : / \ ? ! 0

Contacts management

<i>Directory</i>	Select this softkey to open contacts management.
<i>Add</i>	Create a new contact.
<i>Delete</i>	Delete the selected contact.
<i>More</i>	Access more features.
<i>Call</i>	Call the selected contact.
<i>Detail</i>	Open the contact card.
<i>Delete all</i>	Delete all contacts in the local directory.
<i>AddGrp</i>	Add a new group.
<i>Enter</i>	List all contacts in the selected group.
<i>Back</i>	Return to the main page.





Contact card

<i>Directory</i>	Select this softkey to open contacts management.
<i>Detail</i>	Open the contact card. Modify a contact.
<i>Back</i>	Return to the main page.







Manage the call log(history)

<i>History</i>	Access the call log.
<i>Delete</i>	Delete the selected entry. Note that no confirmation is requested.
<i>Call</i>	Call the selected contact.
<i>More</i>	Access more features.
 or <i>Detail</i>	Open information about the contact: name, number, time, relevant SIP account, duration.
<i>Delete all</i>	Delete the entire log associated with the selected contact. Note that no confirmation is requested.
<i>Missed</i>	Display missed calls only.
<i>AddClist</i>	Add the contact in your local directory. If the contact already exists, the contact card is edited.
<i>Back</i>	Return to the main page.

Making a call

	Select the SIP account to use to make the call. A dial area and the list of last number dialed are displayed.
	Dial the number.
	Calling by name.
<i>History</i>	Call from call log.
<i>Contacts</i>	Calling using your personal directory.
Use one of the following:	
	Press the 'take the call' key. Make the call with the active device: handset if unhooked, headset if connected, otherwise in hands-free mode.
	Press the OK key to start the call. Make the call with the active device: handset if unhooked, headset if connected, otherwise in hands-free mode.
<i>Call</i>	Press the call key to start the call. Make the call with the active device: handset if unhooked, headset if connected, otherwise in hands-free mode.
<i># or *</i>	If defined in the phone settings, you can use these keys to initiate the call (<i>Menu</i> → <i>Features</i> → <i>Key As Send</i>).



Receiving a call

	Lift the handset to take the call.
	Use the headset to take the call. If your headset has no Off-hook/On-hook key, use the phone keys and switch on the audio on the headset.
	Press the loudspeaker/hands-free key to take the call in hands-free mode.
	Press the blinking line key associated with the SIP account receiving the call.
<i>Take call</i> or 	Take the call with the headset if connected, or in hands-free mode.
 or <i>Reject call</i>	Deflect the call to your voicemail.
<i>Deflect</i>	Deflect the call to another contact:

During conversation

<i>End</i>	End the call.
<i>Hold</i>	Placing a call on hold.
<i>Transfer</i>	Transfer a call.
<i>Retrieve</i>	Retrieve a call (on hold, parked).
<i>New</i>	Making a second call during a conversation.
<i>Swap</i>	Switching between calls.
<i>Conf</i>	Establishing a three-party conference call.
<i>End conf</i>	End the conference with all participants
	Mute/unmute the selected participant.

Settings

<i>Menu</i>	Press the softkey settings.
<i>Basic Setting</i> → <i>Sound</i> → <i>Ringing</i>	Select the melody. Adjusting the ringer volume. Configure the ringtone. Configuring discreet mode (beep).
<i>Basic Setting</i> → <i>Sound</i> → <i>DTMF Tone</i>	To activate or deactivate DTMF mode.
 	Adjusting the ringer volume.
<i>Basic Setting</i> → <i>Language</i>	Selecting language.
<i>Basic Setting</i> → <i>Display</i>	Adjust the brightness when the phone is in use. Adjust the dimmed brightness when the phone is not in use. Set the delay before the screensaver starts.
<i>Status</i>	Display IP and MAC addresses and software version.
<i>Features</i>	Access phone features: Call Forward, DND, Auto Answer, Programmable key, Anonymous, Key As Send, Hotline, Default Account, Intercom.
<i>Voicemail</i>	Define voicemail number. Access to registered SIP account voicemail.
<i>Basic Setting</i> → <i>Bluetooth</i>	Manage Bluetooth® device (M7).